

Copy

Television

May
35¢

THE BUSINESS MAGAZINE OF THE INDUSTRY



UNIVERSITY OF CALIFORNIA
LOS ANGELES
MAY 21 1947
ENGINEERING LIBRARY

The speechless commercial

The U. S. Rubber "Campus Hoopla" program on NBC every Friday features "KEDS, The Shoe of Champions" in action. This subtle employment of the television commercial needs no words to sell.

U. S. Rubber and their agency, Campbell-Ewald, are among the far-sighted advertisers and agencies now participating with NBC in the development of effective commercial television programs. Today's combined advertising experience, creative talent and showmanship are building techniques that will win program and sales acceptance in tomorrow's greater television markets.

NBC Television

NATIONAL BROADCASTING COMPANY • 30 ROCKEFELLER PLAZA • NEW YORK

Service of Radio Corporation of America

Curtain Call...

IN YOUR LIVING ROOM



You'll think you're *there*—front row, center—when you see and hear your favorite telecast on a Farnsworth table model or console.

In your own living room, you'll see why the modern, compact table model shown above was the hit of recent television shows. You'll see brighter, clearer, steadier pictures . . . amazingly lifelike . . . on a 10-inch direct view tube that brings out every detail, sharply defines it. You'll see why Farnsworth television is outstanding.

Farnsworth console models, in addition

to television sight and sound reception, include standard radio and/or frequency modulation. Some models also combine the deluxe Farnsworth record changer for complete television, radio and phonograph entertainment in one instrument.

Every Farnsworth instrument offers the superior performance that has been synonymous with the Farnsworth name throughout 20 years of pioneering electronics activity. Farnsworth Television & Radio Corporation, Fort Wayne 1, Indiana.

Farnsworth

Television

Radio

Phonograph=Radio

FREDERICK A. KUCHEL
Editor and Publisher

MARY GANNON
Managing Editor

DOROTHY HOLLOWAY
Washington

T. R. KENNEDY, JR.
Technical Editor

JACK KILPATRICK
Patents

PETER B. JAMES
Business Manager

M. M. PRITCHARD
Circulation Manager

RICHARD ROSE
Art Director

TELEVISION OUTLOOK IN ST. LOUIS 8
Activity in St. Louis centers around KSD-TV—only claimant for the five channels available

HENRY C. LYTTON & CO., CHICAGO RETAILER, ADVERTISES ON TELEVISION 10
Analysis of commercial techniques used on sponsorship of the Sunday night hockey games over WBKB—by Mary Gannon

REPORT ON JOINT TELEVISION COMMITTEE 14
Five talent unions from other entertainment fields get together on a television contract—by Martin Schrader

THE SALESMEN ARE POLITER IN THE MIDWEST—BUT . . . 16
Our “shopper” takes herself to Chicago and St. Louis and tries to buy a television set

WASHINGTON T-WEEK
Sets are selling but bad displays and poor programs dim the picture

TELEVISION RECEIVERS WILL REQUIRE SPECIAL VIEWING FACILITIES 19
Morris Lapidus, A.I.A., shows how a 35'x60' department can be utilized to best advantage

DEPARTMENTS

WASHINGTON 2
No charge on A. T. & T.'s Washington coax link this year . . . FCC actions—by Dorothy Holloway

TELESCOPE 4
Report on latest industry happenings

ONE MAN'S REFLECTIONS
Ideal television receivers—by Dr. Alfred N. Goldsmith

ADVERTISING 21
Current activities . . . 36 advertisers on television last month

FILM 28
Partial list of film distributors with releases available for television

PROGRAMMING 29
Comparative analysis of NBC and CBS programming . . . review of current formats

EQUIPMENT 36
Technicalities of the Zoomar lens . . . high speed film processing

EDITORIAL 40

No charge on Washington - New York coax this year—FCC actions—by Dorothy Holloway

THE American Telephone and Telegraph Company has assured NBC and DuMont that no charge will be made for tele's use of the coaxial cable to transmit network shows in 1947. Coax transmission is still in "experimental" category at the FCC, but recent rumors were to the effect the telephone company was about to ask for authority to fix rates.

What brought the matter to a head most recently was a protest by FM enthusiasts that television was being accorded privileges denied their medium. When the FM pioneers decided to network Washington and New York FM stations here they first asked the telephone company for a 15,000 cycle line on the coax—"for free," of course. The telephone company pointed out that commercial wirelines—other than the coax—were available for FM transmission. The FM'ers took the position, however, that since the phone company provided the video sound channel on the coax at no cost to tele licensees, they should have the same privileges. A.T. & T.'s answer to that one was simply that the sound channel was looked on as part and parcel of the overall tele transmission—which willy-nilly is "experimental" and must be given free of charge.

Crosley Web in Sight

What may be the nucleus of a Midwest television network took shape recently when the FCC awarded the Crosley Broadcasting Corp. its third video station—this one in Dayton, O. The company already holds franchises for Cincinnati and Columbus and has an option to acquire a 49% bloc of KSTP, St. Paul which also holds a tele grant.

FCC's grant in Dayton marked a new liberal interpretation of its multiple-ownership rule for television, since the Dayton station cuts into a good part of the area served by both of the other Crosley stations. Crosley will use top power 50 kw picture and 25 kw sound transmitters on the No. 5 channel in Dayton. Program plans are still hazy, but the company expects to spend \$300-400,000 on station construction and to make no money during the first year's operation.

Tele-Aviation Strategists

The RTPB, FCC and the Radio Technical Commission for Aviation are mapping strategy to head off anticipated interference from tele stations on the No. 2 and 3 video channels (54-60; 60-66 mc) to aviation radio systems. It's another case of harmonics, since the second harmonic of both these channels hits the 108-132 meg region where aviation systems operate. So far no interference has been noted but the experts explain that only three video stations are on the air on either the No. 2 or 3 channels—hardly a fair test. Taking a page from FM's experience, the television men hope to discover a cure before the headache itself becomes apparent.

Attention: AM-TV'ers!

To end confusion among multiple-service broadcasters, FCC wants it made clear that separate applications must be filed when a standard broadcaster mounts a television (or FM) antenna on his standard broadcast tower. FCC said informal applications—letter or tele-

gram—usually will be accepted, although formal application may be required "where a substantial change of structure of a directional antenna system is involved."

Set Production Bottleneck!

Television set production continues to creep along at snail's pace—with only 18,329 receivers turned out in the first three months of 1947. According to the Radio Manufacturers Association, however, rates of production reflect a steady increase in TV set manufacture, with current estimates well over the 450,000 receivers originally scheduled for delivery this year.

RMA breakdown shows 15,498 table models (mostly RCA) produced in the first quarter; 2,761 consoles; 56 radio-phonograph combinations; and 14 converters. However, this may not include all manufacturers as DuMont shipped over 1,000 radio-phonograph combinations.

Like it or not, FCC apparently doesn't consider television any competition to either FM or AM at this stage of its development. Tip-off on the Commission's attitude toward video is found in its proposed FM decision in the New York City-N. J. area.

One of toughest choices was between the New York Post station, WLIB and the New York Daily News. A majority of FCC members chose the News. Their rationale was that an FM grant to WLIB would preclude radio competition between the two newspapers, since the News has no standard broadcast station. A grant to the News would presumably intensify competition between the dailies. In a red-faced footnote, the Commission went on to say that although it was simultaneously awarding the News a television permit for New York City "such a station will not sufficiently meet the interests of competition which we have stressed."

Fight Tower Restrictions

The National Association of Broadcasters and Chief FCC Television Engineer Curtis Plummer have both thrown their weight against the latest of several legislative proposals banning erection of television towers in any residential area in the District of Columbia.

If such a zoning restriction is adopted in the nation's capital it will set the pattern for other cities throughout the country, the industry men have warned the Joint House-Senate subcommittee considering the bill. Under existing laws, they claim, the public is fully protected and local governments have sufficient authority to decide site problems without further legislation.

Color Recess Only

FCC Commissioner E. K. Jett has made it clear that although the Commission has postponed color television for another four to five years, RCA-NBC, DuMont and Philco can't fall down on their color researches.

As Jett sees it, the FCC will keep a close check on the progress of color television and may even call hearings some three or four years hence to elbow the companies into the color field.

Section 303 (g) of the Communications Act, Jett points out, obligates the government to continuously study new uses of radio and "to provide for the larger and more effective" use of radio in the public interest.

“Television magazine is must reading to anyone seriously interested.....”



“TELEVISION magazine is must reading to anyone seriously interested in this new industry.

“Broadcasters, manufacturers, advertisers, agencies, talent and technicians will find much vital information, both general and specific, affecting their own operations.”

Allen B. DuMont

President

Allen B. DuMont Laboratories, Inc.

More and more industry leaders like Dr. Allen B. DuMont are depending on TELEVISION magazine for the factual information which will help them in their television plans and work.

Each month TELEVISION is read by 4,000 key executives in broadcasting, advertising, manufacturing, film production, publishing, department stores, and other closely allied fields.

Whether you are selling equipment, station time, programs, film—in fact whatever you are selling in television you'll find TELEVISION magazine, the industry's only monthly publication, the most effective medium to reach the men who buy.

TELEVISION magazine, 600 Madison Avenue, New York 22.

May, 1947

STATIONS: Delays due to materials and equipment shortages, deliveries, CPA restrictions on building and CAA's approval of tower sites has changed FCC's entire licensing procedure. Now construction permits are not made effective until CAA approval is given on the site. Permittee is then given the normal 60-days in which to start construction and another six months in which to complete it. In no case, however, has a television broadcaster made the deadline. Usually, he is given three or four or even more extensions of 90-days each to allow for the inevitable delays along the line. Thus while FCC's records indicate that almost all tele stations will have completed construction in 1947, truth of the matter is that probably only about twelve more stations will open up.

Stations with allocations on channels above 7 aren't too anxious to leap into operation until they have more dope on performance of tubes in these frequencies.

Box Score

Score now reads 11 operating stations (10 commercial and W6XAO Don Lee experimental), 55 grants and 8 pending. Of those pending, New England Theatres, Boston; Interstate Circuit, Dallas; United Detroit Theatres, Detroit; and DuMont applications in Cincinnati and Cleveland, are awaiting FCC disposal of the Paramount-DuMont stock issue. Go ahead for Don Lee's W6XAO and another application in San Francisco are also awaiting disposition of AM radio network charges. These, with the recently filed application of Sarkes Tarzian of Bloomington, Indiana and the amended bid of the Philadelphia Daily News, (re-filed under the name of Daily News Television Company), are the ones awaiting final FCC action.

Sarkes Tarzian, who has applied for channel No. 10, has asked the FCC to reassign it from Indianapolis to Bloomington (Indianapolis already has one permittee—the William Block Department Store). Tarzian plans to construct the television station himself. He will use DuMont equipment and expects to get by for the rock-bottom construction price of \$38,270.

Timetable

NBC's WNBW has finally received bulk of its video transmitting equipment and will make its debut early in May. John Gaunt, former Navy Commander, Hollywood film director and NBC radio producer, has charge of programming the Washington station. George Sandifer, his sidekick, handles the technical end. For the first month or so, Gaunt said, WNBW will rely entirely on NBC's New York station WNBW for its program fare.

WNBW's originations will be primarily in the field of news and special events during the early months. Gaunt and his staff have been huddling on ideas to dramatize the news . . . NBC already has informal clearance from top committee chair-

men on Capitol Hill to televise their hearings and press conferences.

Later on, WNBW hopes to do live dramatic studio productions. Right now, NBC has use of the coax only two nights a week but is looking forward to this summer or fall when the A.T. & T. is expected to open another cable link between Washington and Philadelphia to accommodate more television programs. The present cable from Philly to the capital has only two tubes, one to Philly and the other from Philly to Washington. The Philadelphia to New York link has six or eight tubes capable of carrying several video programs simultaneously. In order to equalize service on the Washington end, A.T. & T. will have to expand its cable facilities or speed completion of its radio relay system for TV.

Chicago may have WGN on the pix waves by the end of the year with remote programs. Station already has two remote cameras, and has leased space in the Daily News building for studios. NBC is also under way with studio space leased in the Civic Opera Building. ABC will concentrate on their New York station before tackling another city.

Southern Radio and Television in Miami also hopes to be on by the end of the year. Their operation is planned toward developing a program pattern for a small market and will cater mostly to local advertisers. Initial programming will concentrate on remotes with studio equipment ordered from DuMont to consist of two field pick-up cameras, one station wagon, and 16 mm. film equipment. Station also plans to act as a production unit for Florida hotels and to produce programs on film which can then be shown over other stations. Present plans do not call for any dramatic shows. They have also entered into an agreement to distribute DuMont receivers throughout Florida. Robert Venn heads the operation.

Farnsworth hope to have their experimental station in operation by the beginning of 1948. They are building studio cameras and control equipment along with the transmitter, which will be tested in the station. As soon as conditions warrant, station will apply for a commercial license.

WWDT, Detroit, which has been operating experimentally a few afternoons a week with a temporary antenna, will begin full scale operation this month. RCA, Viewtone and DuMont receivers have been on display since March with T-Day finally scheduled for May—probably to coincide with some big sport event.

NEW YORK DECISIONS: Recent FCC grants to ABC, Bamberger, Bremer (WAAT, Newark) and the News Syndicate settled the New York controversy after nearly ten months of FCC debate. Debs, who lost the fight, was rejected on the grounds that their limited funds would not permit fast development of television service.

Bamberger will spend more than \$650,000 on

construction of transmitter, studios and equipment. Studios will be in the WOR building at first. News has earmarked nearly \$600,000 for their initial costs, with studios to be located in the News Building. ABC estimated an expenditure of about \$900,000 on construction costs with no definite studio site selected yet. Bremer, with plans for a studio in the Mosque Theatre Building in Newark, will spend about \$212,000 on equipment and construction.

Decision gave ABC its fifth outlet, with other grants in Los Angeles, Detroit, Chicago and San Francisco; and Bamberger, with a grant in Washington, D. C., its second.

With the possible exception of Bremer, there seems little likelihood that any of the other stations will be on the pix waves this year.

RECEIVERS: Farnsworth production lines are now set up and token deliveries will start in June with production in full swing by September. Estimated total for the year is 60,000 receivers. First model will be the 10 inch table set retailing for approximately \$350. An AM adapter, with five pre-selected stations, can be added for approximately \$35. Second model will be the console with 10" tube and AM, retailing around \$425. Third will be the Highboy, 10" tube, AM, FM and automatic phonograph for around \$800, and fourth the Lowboy with 10" picture, AM and automatic phonograph retailing for about \$600. Production on projection model, using polaroid lens, will probably not start until the spring of 1948.

Service and training program is now in the works. Training program consists of seven meetings illustrated with lantern slides and drawings. Material is reproduced and given to the men at the conclusion of the course. This course, which has been given to their factory people, will be repeated for distributors, dealers, and installation depots in television cities. Service plan will probably be similar to RCA's. Distribution will start first in the New York area.

U. S. Television's 1947 estimate is 5000 projection sets and 1500 of the 10" consoles. Distribution is estimated at 50% for New York and 10% each for Chicago, Philadelphia, and Washington; 8% in St. Louis, 5% each in Los Angeles and Detroit; 2% in the Schenectady-Troy-Albany area. 21 x 16 inch sets are priced at \$2350 and \$2400; 10" model at \$895. All include AM, FM, short wave and automatic changer.

Emerson 10" console, including FM and AM, retails for \$450. Distribution is starting in New York, Philadelphia and Chicago to be followed by the other areas shortly. 10 inch table model is now in production.

EQUIPMENT: Zoomar lens, which was developed by Dr. Harold Back under sponsorship of Jerry Fairbanks, will probably have its greatest application in remote pick-ups according to O. B. Hansen, NBC VP in charge of engineering. Use of the

lens may make it possible to get a 3-camera effect by using only 2—one regular I.O. turret lens and the other equipped with the Zoomar lens. In the comparative studio demonstration with image orthicon, Zoomar pick-up lost in definition. The technical explanation of the Zoomar lens will be found under EQUIPMENT on page 36. Farnsworth have developed a 16 mm. and 35 mm. continuous film projector. Company will not go into production on either but will license some manufacturer to make them. They are also building the studio equipment for their experimental station. The camera is equipped with an electronic view finder, can go up 8 ft., has a full 180 degrees swing and a 90 degrees tilt. This is worked by mechanical controls which the cameraman operates and requires only one dolly pusher. Console equipment is designed for small station use and actually one producer and one technician could handle it although the general average would be two technicians and the producer. It is built in small sections with the producer doing the switching, fading, dissolving, etc., at that point. The console is designed to handle up to 10 cameras and is built in sections for easy servicing. Once equipment has been tested in their own studio under actual operating conditions and adjustments made, if necessary, company will probably build the equipment on a commercial basis.

ADVERTISING: Thirty-six advertisers were on television during April. Kraft, Swift and Kelvinator are scheduled to start in May over WNBT; Sanka's weather reports will begin over WABD around May 19th, and there are strong indications that other big-name contracts will be announced shortly. (For details on current activities, turn to ADVERTISING, page 21).

TELE TOUR: Intra-store television is to get another shot in the arm with the tour of "Television Caravan" to Allied stores in 22 cities. RCA equipment will be used with about 14 shows given at each store on the trip. Ten advertisers are cooperating — Charm, Pic, House Beautiful, Westinghouse, Hickok, B.V.D., Koroseal, Sherwin-Williams, Hoover and U. S. Rubber. In addition to live product demonstrations from studios constructed in the store, programs will also consist of sports films, etc., to give people an idea of the program fare they would receive over a television set.

Purpose of set-up is to determine effectiveness of television as a traffic-getter and selling medium for retailers; to educate store personnel by giving them a first-hand opportunity to study the medium; to determine public reaction, and to bring television to sections of the country which have never seen it. Sam Cuff heads the tour, with Lou Sposa as production manager and Lorraine Wolfe as advance agent (all formerly of DuMont). Bernard Brink is chief engineer. Twelve persons will be included in the entourage, with the RCA equipment, estimated at about \$100,000, being carried in six specially built autos from place to

(Continued on page 38)

New mobile studio



RCA image-orthicon cameras, standard equipment for the new truck, rival the human eye in sensitivity—eliminate fading of sports events. Shown above as used by Philco's WPTZ to pick up a Penn game at Franklin Field, Phila.

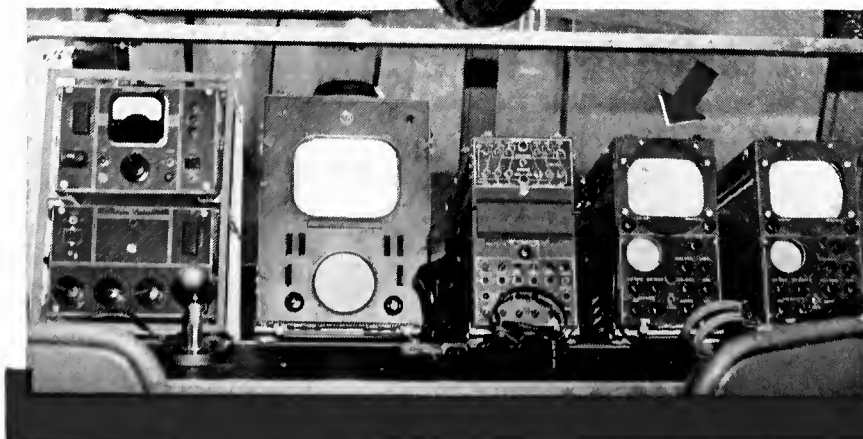
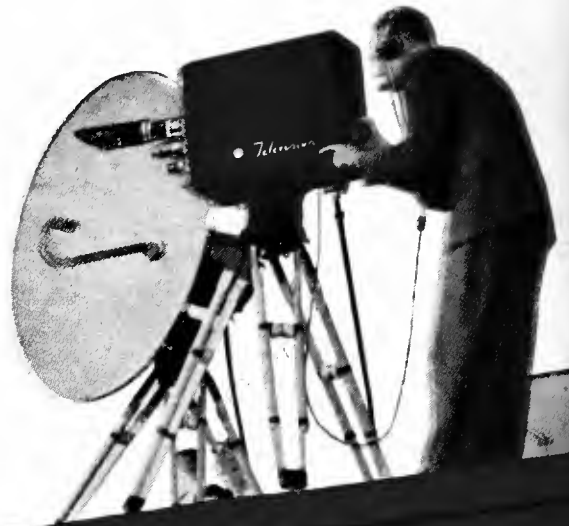

REMOVABLE, SUITCASE-TYPE CONTROLS SPEED SPECIAL SETUPS

Where advantageous, all necessary equipment can be easily removed from the truck, carried to program areas, and quickly set up by means of plug-in type connectors. View

Simplifies at-the-scene telecasting

Opens up a wealth of diversified, low-cost program material

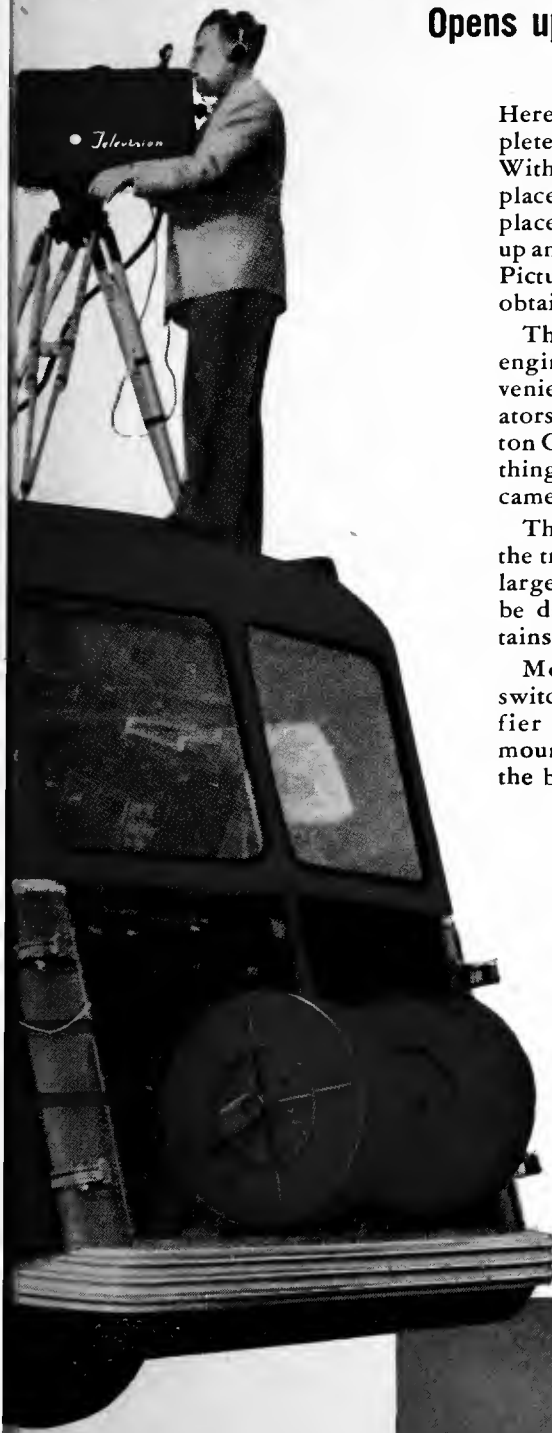

Here, in one compact unit, is a complete television "studio on wheels." With it you can move rapidly to the places where local events are taking place and, with minimum effort, pick up and relay the action to your station. Picture quality is comparable to that obtained with studio equipment.

The truck body, designed by RCA engineers to provide maximum convenience and working space to operators, is mounted on a standard 1½ ton Chevrolet chassis. It carries everything you need to operate a three-camera television chain.

The control desk is at the back of the truck, flanked on three sides with large full-vision windows. These can be darkened by means of draw curtains when desirable.

Monitors, camera controls, a switching unit, and an audio amplifier and mixer are conveniently mounted on an inclined support at the back of the desk; pulse formers,

shapers, and power supplies are installed underneath. All units are of the removable, suitcase type.

Shock-mounted lockers provide ample storage space for cameras, tripods, microwave relay transmitter, and other gear.

The roof of the truck has been strongly reinforced for use as an operating platform, when needed. Access is via a removable ladder inside the truck and a roof hatch. However, the cameras can be operated as far as 500 feet from the vehicle, if desired. Four cable reels, mounted on swinging arms in the rear truck compartment, permit easy unwinding and storage of camera cable. Each has a 200-foot capacity.

Here, we believe, is a real opportunity for diversified programming—a quick, convenient method of making remote pick-ups. It will pay you to include such a unit in your television plans. Write Dept. 79-E.



TELEVISION BROADCAST EQUIPMENT

**RADIO CORPORATION
of AMERICA**

ENGINEERING PRODUCTS DEPARTMENT, CAMDEN, N.J.

In Canada: RCA VICTOR Company Limited, Montreal

Shows suitcase-type units as installed at the rear of truck. View at right shows how such equipment is used by WMAL, Washington, D. C., for indoor television pick-up.

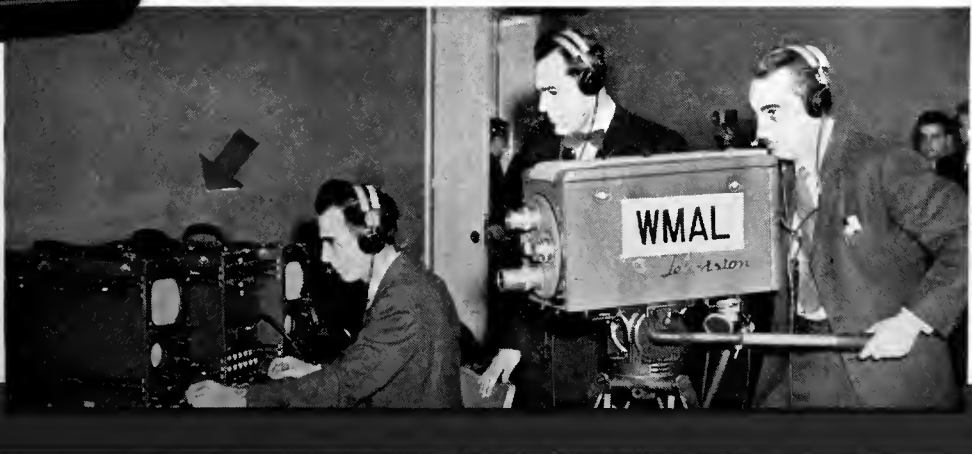

television outlook

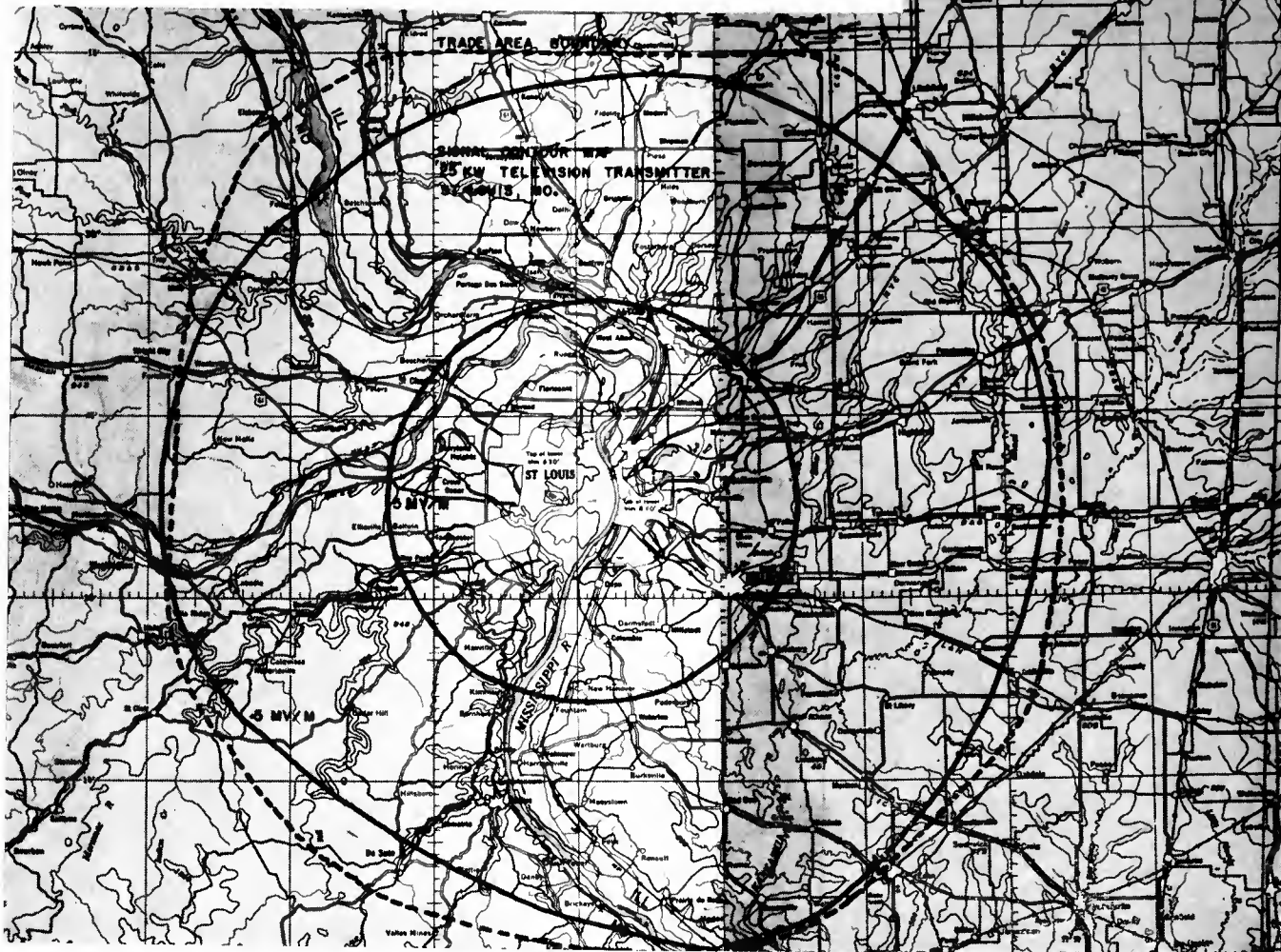

Black lines indicate both the primary and secondary coverage given by a 25 kw. station, assuming that the antenna is 500 feet high and located in the center of the business district. Dotted lines indicate the trading area boundary.

in ST. LOUIS

RANKING 10th in sales and with a trading area of over 1,500,000 people, St. Louis boasts the first postwar-equipped television station to hit the pix-waves—KSD-TV. With five channels allocated to St. Louis, the four remaining have no claimants—although feeling is that they won't go a-begging long in such a market. Originally, there was a name tagged to each slot—but with the withdrawals of Michael Alfend (Alfco Company); Globe-Democrat Publishing Company; Star Times Publishing Company; and Thomas Patrick, Inc.—KSD-TV has the field to itself.

KSD-TV

Owned and operated by the St. Louis Post-Dispatch—which also controls NBC-affiliated radio station KSD—the new television outlet debuted February 10th and has been on the air a minimum of five days a week since, with an average of 20 hours programming weekly. At the helm is George M. Burbach, general manager of KSD and KSD-TV and Robert L. Coe, station manager of the TV station.

Opening in a temporary studio, measuring 25'6" wide, 43'3" long and 21' high, operations were begun with two image orthicon cameras, two boom mikes, hanging mike and 16 mm. film equipment. Temporary transmitter gives a range of 8 to 11 miles, with the complete transmitter covering at least a 40 mile radius

slated for installation in May. Also on order is 35 mm. film equipment, studio control equipment, and a mobile truck unit with two additional image orthicons.

Emergency measure of starting studio programming with image orthicon cameras has proved so successful that KSD-TV has decided not to install regular studio cameras. Biggest immediate advantage is the easy solution given the lighting problem. Lighting, designed by station engineers, consists of 10 overhead fluorescent light banks of six each, four baby spots and four strip lights, giving an overall illumination of about 100 footcandles. There's no heat problem and in the opinion of the station staff, more intricate lighting effects can be obtained than from the flat lighting which has been all too common on television. In addition, image orthos with turret lenses, simplify studio operation, eliminate dolly pushing, and give a lot more freedom in the use of cameras. The 100 footcandle light level is generally used, although they have gone as high as 150 footcandles.

Program Schedule

For the first two months, programming schedule was aimed at dealers rather than home viewers. Originally, station was on the air Monday to Friday inclusive, with two hours of afternoon programming

from 3 to 5. Evening time varied, with station opening some nights at 7 and others at 8:30 when there was a sports event to pick up.

Now, however, station is including Saturday and Sunday afternoon and evening programming, and dropping one or two of the week-days.

Whole program structure steers clear of production and writing problems, with emphasis on remotes, films and extremely simple studio shows. Because of limited staff, set formats are repeated, thus reducing rehearsal time on these particular shows, and allowing more time for new formats. At present, no dramatic programs are planned.

Set Formats

Typical of the studio programming which is being done are the following. "News and Views," late news program, is visualized by a large variety of still photos. (Station has purchased first rights to use AP photos; may later buy INS.) Fifteen minute program, on daily under the initial set-up, has now been cut to a few times weekly. For the half-hour "Man on the Street" show, cameras are pushed out in front of the building and passers-by interviewed. Program now runs two or three times a week although it was a daily feature formerly. "News in Sports," twenty-minute weekly program, is a demonstration of sports techniques, such as wrestling, golfing, baseball, etc.

"St. Louis Personalities," another regular, brings well-known civic people face to face with the television audience. Interview format is used, with background and aims discussed, and visualization given through exhibits, pictures, graphs, etc. Show usually runs 15 to 20 minutes, once a week.

Local choral groups are also used, garbed in ecclesiastical robes, and occasionally a religious leader gives a discourse, against a simulated pulpit. Forum type shows are another feature, with an office setting used for civic topics and a living room set for topics usually discussed in a home.

Remote Set-Up

On remotes, station has a tie-up with both St. Louis baseball teams—the Browns and the Cardinals. In addition, they have televised the recently concluded basketball and hockey games, wrestling and boxing. Special events have included the St. Louis Police Circus, the Easter Parade, the Ice Show, the Flower Show, etc.

Operating as they do now with just the two cameras means that the equipment must be moved out of the studio to the remote point—with the commercials

given right at the location, rather than switching back to the studio. However, with the expected delivery of the mobile equipped truck, such emergency measures can be suspended.

Micro-wave relay outfit, which operates from line of sight or close to it, is used in place of telephone lines, whenever feasible. Although equipment costs \$9500, sta-

tion feels initial investment is justified when stacked up against telephone company quotations for video circuits. As an example, quotations on one video circuit, which runs ½ airline mile, was estimated at \$280 a month, plus \$1000 installation costs; another, running 6 airline miles, cost \$500 to install, with a carrying charge of \$810 a month. It's their feeling that wire lines might be practical from points used constantly—they have such a line installed at the arena.

Commercial Policy

However, station does realize that they must build package shows, that by so doing the commercial end of television will develop much more quickly. In a city where television is so completely new and where few people have had the experience of working with it, they feel that such a step is important. Right now, station is inviting agencies to work with them.

Tentative basic time costs have been put into effect as a reasonable starting basis. Under this set-up, charges for one hour have been pegged at \$150; ½ hour, \$90; ¼ hour, \$60, with a two to one rehearsal ratio included. (Complete time costs given in April TELEVISION Industry Report.)

TAP Training

To go back a bit, image orthos were delivered to the station last September and closed circuit experimentation carried on for purposes of training the staff. About three weeks before the opening Television Advertising Productions, headed by Arden Rodner, was called in to train the staff and prepare the programming for the opening.

Radio personnel, drawn from KSD, were used and an intensive training schedule instituted, with the new recruits learning by doing. After two days of rotating on equipment, so that everyone would have an idea of the overall operations, men were assigned to definite jobs. TAP handled the entire job of producing the opening week programming, wrote the scripts and worked closely with the agencies on the commercials. Twenty-one hours of live studio shows were put on—with 51 hours of camera rehearsal. TAP attributes low rehearsal ratio to the fact that, first, scripts were written with camera action in, and second, that they would go through entire show and note the rough spots; then the producer and director would talk it over, make changes, and go through it again. This eliminated stopping after every little point. Over 15 sponsors were represented during the first week.

Right now, station has Hyde Park Breweries, Greisdieck Brothers, Purity Bakeries, and Botany signed on a regular basis.

Campaign to make St. Louis television-minded is well underway. "Television Is Here" signs are on cabs, street cars, trucks, store windows. Bars, grills and hotels are eager for sets.

With an eye toward the load building possibilities of television, Union Electric is taking an active part in promoting local in-

(Cont'd on page 35)



George M. Burbach
General Manager



Robert L. Coe
Station Manager

HENRY C. LYTTON CO., CHICAGO RETAILER, ADVERTISE



ON TELEVISION

BY MARY GANNON

SLOGAN, "Look to Lytton's for trade names of quality," meant a double selling job in the commercials when the large department store signed up for television last fall. For it gave Ruthrauff & Ryan's tele director, Fran Harris, the job of not only selling the store but also particular brands of merchandise in the two commercial spots each Sunday night. Under ABC's arrangement to buy the hockey games over WBKB and then split the costs with an advertiser, store's first venture into television was the sponsorship of the Sunday night hockey games over WBKB. During the fourteen weeks that the season ran, over 40 items of merchandise were plugged in the 28 commercials.

Standard opening and closing was used, with six miniature billboards against a panorama of sky and skyscrapers, as illustrated above, carrying identifying copy. Camera dollyed the full length of the miniature, to create the impression that the viewer was seated in an auto and riding down the highway. Closing commercial presented an invitation to the following week's game.

After the opening commercial, station switched to the Chicago Stadium where the announcer gave the team line-up and general colorful information on the players, together with pick-ups of the teams in their

pre-game warm-ups. Elaborate explanation of the principles of ice hockey were presented before the initial telecast and was repeated in briefer version intermittently thereafter. Feeling was that while new receivers were being installed daily—and new viewers added for every telecast—nevertheless care had to be taken to avoid boring the seasoned viewer. Hockey games were under the direction of Reinald Werrenrath, WBKB director of remotes, and Fred Kilian, ABC producer.

Natural time break for the main commercials came at the two periods in the hockey games. Here the agency experimented almost continually to find the best time segment for a commercial—ranging from a minimum of three and one half to eight and one half minutes. And audience reaction proved that the viewer does not sit with a stop watch—it's the effectiveness, the interest which can be sustained, the entire method of presentation which determines whether the lookers-in watch the commercial or pick that time to go in search of a drink.

Merchandise Selection

Commercials were really rather elaborate skits with the available facilities kept in mind at all times. Scripts were written around the merchandise which was care-

fully selected to show up dramatically. Once the items were set, agency scouted the merchandise, gathered all the copy points, created a situation and passed the information on to Betty Babcock, who then wrote the scripts.

In selecting merchandise, the entire scene and the people in it had to be visualized as a whole, so that the apparel showed up well against the background, and the individual costumes, when grouped, did not clash. As Fran Harris put it, "We didn't want a girl in a print dress sitting on a couch with a huge chintz print cover. Nor a girl in a checked suit sitting at a table with a checked tablecloth. We tried to plan each frame so that it would be pleasing to the eye."

Where a print was used for background, such as in one scene when the action took place in front of a table with a huge beach umbrella, the models stayed far enough in front of the background so that there was no clash.

In selecting prints, there had to be enough contrast so that it stood out from the background color of the dress. Otherwise it was eliminated. "The viewer's eyes must see the item in full detail. If it cannot, we are not selling the item via television and we are under-selling the medium" . . . again to quote Fran Harris.

Not only colors but materials had to be taken into consideration to guarantee effective color contrast. Material that absorbs light shows up darker than it actually is and material that reflects light shows up shades lighter. Smart as it is in person, high fashion basic black with white accessories is not telegenic. The black *absorbs* too much of the light and the white *reflects* too much of the light . . . consequently the reflected light is caught by the black and the grey halo which results doesn't help the model, the clothes—or television. To get the same effect, a blue suit or dress and yellow or pink accessories were used. Tweeds, prints, plaids, stripes were favorites though and presented few problems.

Commercial Treatment

Almost all commercials carried a gag twist, with many different techniques tried—pantomime with off-screen announcement in some; in another, the camera used as an audience; still another, the suit itself playing the principal role, with the camera-beheaded actor using stylized movements and talking in a slangy, tough style to put over the idea of a guy who was pretty proud of himself.

But most interesting experiment from the viewpoint of testing the effectiveness of sustained commercials over a long period of time, was the one in which the name "Lyttton" was not mentioned once. It was done deliberately to see if television registered after 11 weeks. While no formal research was conducted nevertheless they received such typical comments as, "They didn't mention Lyttton's once," along with others who when questioned hadn't noticed the omission but knew that Lyttton's was sponsoring the games.

Film sequences were also used for some shows. A good example of a script that combined film, live and pantomime—plus a very novel way of skirting any censor trouble—was the one which plugged bras and girdles. Live modeling on that one? Hardly!

Scene opened on a very feminine boudoir with Alice tying her dressing gown, lighting a cigarette and opening her mail. Off-screen narration identified Alice and the bills she tossed aside, but pointed up the invitation to a formal affair and her quick shift of interest to *the dress*. But the camera eyed the dress and it was



Fran Harris, R. & R. producer, with WBKB director Beulah Zachary and studio manager Lewis Goma-vitz in a pre-show conference on the commercials.



Negligee is displayed to good advantage here.



Husband's reluctance to ask for lingerie gives the salesgirl a chance to show other merchandise.



Rainwear gets the plug here with three men, dressed for a rainy occasion, discussing their outfits.

W.W. Cole, Executive Vice President, Lytton's:

"Lytton's is finding its first venture into the field of television an interesting experiment and one which seems to have a number of significant possibilities. Obviously the opportunity in televised commercials provides an effective method of displaying apparel to advantage and we have received many favorable comments, written and oral, on the high entertainment value of the skits which we are using for our commercials. In fact, one critic went so far as to describe them as the most interesting part of the program.

"We feel that the experiment has contributed considerably to the prestige of our organization and to an interest in the merchandise displayed."



pronounced too snug in certain places. Dissolve into film was made, with the guests shown at a swank affair and Alice arriving, looking like an overstuffed lion, with the belt popping off as she entered. Quick shift picked up the whispering comments of the women, the raised eyebrows of the men, and Alice's agonized eyes. Switch back to the studio, showed Alice hanging the dress away, then picked up the store front and dissolved into the department. Salesgirl showed the bra and girdle, explained their features as she held them out. Next shot showed Alice entering her room with the boxes. Dissolve to film was made, with Alice, smoothly gowned, entering the party, this time greeted with looks of approval.

Sample Script

Reprinted below is one of the scripts used, with a running time of 3 minutes:

Scene: Living room of small apartment. There is sudden and vigorous knocking on door. Ginny, who has been sitting in chair and reading, hurries and opens door. Gerald stands there looking very distraught, holding large box. Rips off hat and demands bluntly . . .

Gerald: "Have you got it?"

Ginny: "Some of my friends tell me I have." (She is an Eve Arden kind of character.)

Gerald: (Ignores her) "My box. It's just this size . . ."

Ginny: "Why should I have your box?"

Gerald: "And it's addressed to me."

Ginny: "Then you must have it."

Gerald: "But I don't. That's just it."

Ginny: "Well—what do you call *that*?" (She points to box he's holding.)

Gerald: "It's a box, of course. But it isn't mine."

Ginny: "No?"

Gerald: "No. It's yours."

Ginny: "Look—"

Gerald: "You see—it's addressed to you." (He shows her label.)

Ginny: "So it is."

Gerald: "Are you Ginny Allen?"

Ginny: "How do you do?"

Gerald: "Oh, Gerald Fox. So—give me mine."

Ginny: "Your—?"

Gerald: "My box. If you're Ginny Allen, then this is

yours and you have mine. Just like Mrs. Haggerty said."

Ginny: "What has Mrs. Haggerty got to do with it?"

Gerald: "She said two boxes came from Lytton's today. One for you and one for me and she might have gotten them mixed up. And—this certainly isn't *mine*! It's a red dress!"

Ginny: "Don't you like red?"

Gerald: "Of course. But not on me! I mean—not in a dress."

Ginny: "Oh, come—you're too conservative!" (They back into room on the business of his offering and her refusing the box.)

Gerald: "Mine is a suit! And you must have it."

Ginny: "Oh, no, I couldn't. Really! Don't ask me to."

Gerald: (Truly exasperated) "You have the box with my suit. (Pause) Haven't you?"

Ginny: "What did you say your name was?" (She wanders casually into next room. Picks up box like one he has. Reads label.)

Gerald: "Look—this is very important! It's a *new* suit and—"

Ginny: (Reading) "Gerald—R.—"

Gerald: "Fox. Gerald R. Fox. Thank you. Thank you very much." (Foolish flurry of exchanging boxes. He's so anxious one drops—they both pick it up—bump heads, etc. When he has his he relaxes against door for first time but still clutching box.)

Ginny: "Feel better?"

Gerald: "I should say so! (Awkward pause) You hadn't even noticed?"

Ginny: "I just got in."

Gerald: "Mrs. Haggerty must have gotten them mixed up. It *sure* is lucky I got them straightened when I did!"

Ginny: "Oh—you needn't have worried. I hardly ever wear men's suits."

Gerald: "Oh—I know—but—"

Ginny: "Is this suit made of cloth of gold or something?"

Gerald: (Deadly serious) "Oh, no. It's an all-purpose worsted."

Ginny: (Deadly) "All-purpose worsted. Something that won't keep over night?"

Gerald: "Gosh—you know about worsted. It'll keep forever!"

Ginny: "Then what's this terrible fever about get-

ting your suit back in such a hurry? What makes it so special?"

Gerald: (Almost religious fervor) "This — is a Clipper Craft suit!"

Pause:

Ginny: (Dull) "Clipper Craft?"

Gerald: (Unbelieving) "Don't you *know* — about Clipper Craft?"

Ginny: "Well—not *all* about—"

Gerald: "Have you got a closet?" (Suddenly looks about wildly.)

Ginny: "You want to develop some pictures?"

Gerald: "If you've got a closet, I'll change."

Ginny: "Oh, no—I like you just as you are—shy, intense, slightly nutty—"

Gerald: "No—I mean I'll change into my new Clipper Craft suit. Wait'll you see it!"

Ginny: "Sure. Right over there. It must be a pretty terrific suit to get a grown guy like you so upset." (Relents a little. Points to closet door. Gerald goes in. Ginny leans against foyer doorway, arms folded.)

Gerald: (From closet) "It's terrific, all right! *This* — is a real suit!"

Ginny: "Cost a fortune?"

Gerald: (From closet) "Do I look like I *had* a fortune?"

Ginny: "Just this side of a fortune."

Gerald: (From closet) "That's what's so wonderful about Clipper Craft. It looks like a fortune. But—actually—it's very reasonable. Are you ready?"

Ginny: (Slightly bored) "I can hardly wait." (Gerald comes out of closet in Clipper Craft suit. Actually looks pretty smooth. (Had slacks on all along, of course.) We assume he's put *other* suit in box which he now puts down on chair so he can model Clipper Craft. Spirals around proudly a couple of times. Ginny is stunned. It *is* snappy. She goes up to examine it closely.)

Gerald: "Well—how do you like it?"

Ginny: (Genuinely impressed) "That's—a handsome suit!"

Gerald: "I've been telling you."

Ginny: "It's beautifully tailored—and it's got real style."

Gerald: "That's Clipper Craft! You like it, huh?" (Veneer broken, she openly admires it.)

Ginny: "Yep. I understand now. That suit is *worth* getting excited about!" (Gerald models a bit more happily. Then suddenly stops and looks at her.)

Gerald: "Say—I'm sorry what I said about your new dress."

Ginny: "Oh—that's okay. You were probably right."

Gerald: "No—I—"

Ginny: "It probably wouldn't look very well on you."

Gerald: "No. But I bet it would on *you!*"

Ginny: (Softens) "Well—as a matter of fact—it is sort of nice."

Gerald: (Impulsively) "Put it on!" (Their personalities seem to change places as Gerald becomes sure and aggressive and Ginny stammering and girlish.)

Ginny: "Oh, no, I—"

Gerald: "Are you doing anything tonight?"

Ginny: "Why, no—I—"

Gerald: "Put on your new red dress." (He picks up his box. Puts on his hat. Starts toward door.) "I'll be back in fifteen minutes. We'll go out. We'll celebrate! We'll celebrate Clipper Craft suits, your new red dress, Lytton's, and us! Okay?" (Ginny nods dizzily.) "Swell! Make it snappy! Fifteen minutes!" (He goes out and slams door.)

(Ginny leans back against closed door for one stunned moment. Then grins and snaps into action. Picks up her box from Lytton's and starts happily off.)

Shopping Programs

Programs preceding Christmas were geared to shopping problems. Typical example of good build-up was the case of the flustered, indecisive husband who went in to buy his wife a gift. What he really wanted was some ultra-fluffy lingerie but before he got nerve enough to say it, his indecision gave the salesgirl a chance to show him scarfs and demonstrate various ways of using them; bed jackets, housecoat, brunch coat and velvet hostess gown, finally leading up to trousseau lingerie. Visual interest was added and a good selling job done by having models show the lingerie to best advantage. Touch of humor—and fact that many a husband-viewer felt akin to his television counterpart—helped make this eight-minute plug one of their best commercials.

Following this in the second period was a straight commercial with a man and wife doing their shopping and complaining about the gifts for each other's relatives. On reaching a gift suggestion table, they picked up slippers, hats and gloves, umbrella, costume jewelry, lingerie bag, evening bag, stocking bag, etc. Camera came in for a close-up and their off-screen conversational patter identified the articles and the type of person to whom they were giving it.

An analysis of the scripts showed that merchandise facts were given and definite tie-in to the type person for whom the gift would be best suited made—thus adhering to basic selling principles. With mother and daughter doing the shopping for dad's gift; with father and son buying something for a little girl—each had a

(Continued on page 39)

Models showed off their beach suits as they went through the motions of playing on the beach. Off screen narration was by the wife, talking her husband into a vacation.



REPORT ON THE JOINT TELEVISION COMMITTEE

An analysis of the temporary agreement talent unions have made among themselves for entries in television.

BY MARTIN SCHRADER

IN A recent magazine interview, Sam Wanamaker, co-starred with Ingrid Bergman in "Joan of Lorraine," remarked that while an actor's greatest creative rewards come from the legitimate theater, it is radio which supplies his bread and butter. Wanamaker's point was well taken, since surveys have shown that the average actor on Broadway earns about \$600 a year, but more than doubles that income through radio work.

But supplementary earnings through radio can become a small part of most actors' incomes when television finally bursts out of its short bristles. It is to television that most run-of-the-Walgreen performers look for a steady, and possibly lucrative income. Actors—and by extension their unions—have a deep personal interest in the success of television. Most of them feel that a vigorous television industry means precise and definite rewards for them—and they are doing all they can to work with television management to insure speedy and complete fulfillment of all the optimistic predictions.

Very simply stated, the principle of enlightened self-interest is the reason for the temperate and intelligent attitude which the actors' unions have taken toward television. That is why unions which in normal circum-

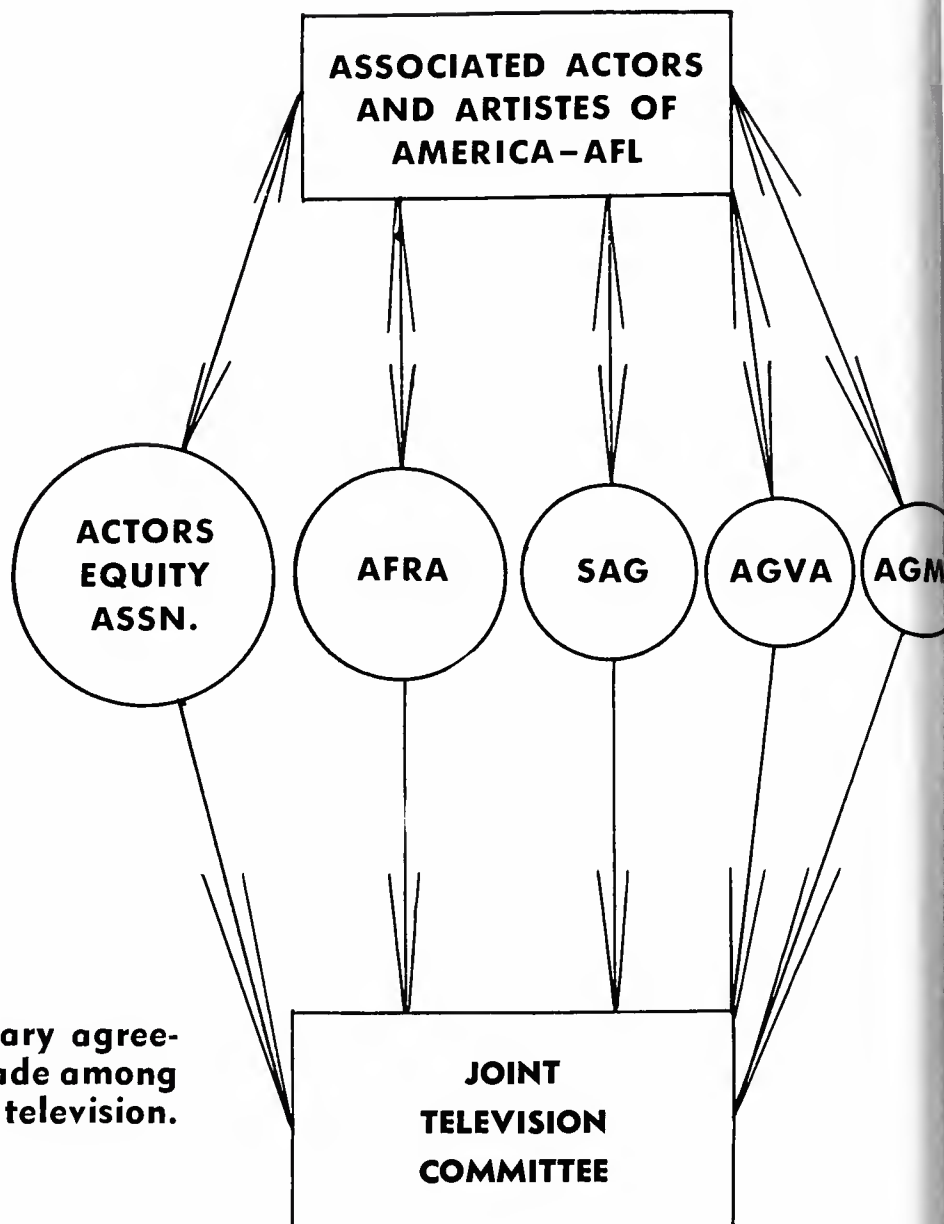

stances fiercely guard their jurisdiction have decided to establish the practical equivalent of an industrial union for television. That is why the actors' contract proposals, when they are submitted about two months hence, will be sane, moderate and well considered.

Basis of Proposals

Five unions, all part of the Associated Actors and Artistes of America-AFL (the 4As) have joined together in the Joint Television Committee which is at this moment establishing policy on wage scales, working conditions and related matters. Their proposals will be based on statistical material gathered over the course of three years from reports of members who have worked in television; reports on prevailing wages, hours of rehearsals and other matters.

This material is being compiled by committees in New York, Chicago and Hollywood. When discussions and meetings are completed some two months from now it is safe to assume that video management will be presented with a set of proposals which will ask *lower* wages than those prevailing in radio (\$36.25 per half hour commercial, \$8.75 per hour commercial rehearsal; \$34.40 per half hour sustaining including up to 4½ hours rehearsal). There will be demands

for payment for rehearsal time and some union leaders predict that there will be some attempt to protect members who are "frozen out" by a great number of special events shows. Just what form this protection will take—whether it will be an effort to sign up all commentators and announcers or whether it will go off in some other direction—is not yet known. But it will be a problem.

The unions will doubtless ask for some form of the closed shop, the most likely proposition being the "union shop," in which the performer need not be a union member *before* he is hired, but must join after he starts work.

The unions will ask for contracts of not longer than one year, feeling that in a constantly growing industry, there will be a need for frequent wage adjustments as television becomes more profitable and more able to pay higher rates.

There will be a definite effort to prevent what the unions call "split shifts." By this they mean rehearsals which begin in the morning, are broken up for a few hours to set up lights and cameras and then resumed at inconvenient times. They will ask for rehearsals as one unit and may propose payment for time spent waiting in the studio while technical problems are being worked out.

Jurisdiction

For a very long time, television has suffered the effects of jurisdictional squabbles among the technical unions. And there has been great fear that the actors would fight out their problems over the body of television management. However, it seems less likely today that there will be jurisdictional disputes than ever before. The performers' unions have banded together into a committee which will have almost complete control over television. Members in good standing of any one of the five unions (Actors' Equity Association, American Federation of Radio Artists, Screen Actor's Guild, American Guild of Variety Artists, American Guild of Musical Artists) will be issued a special 4As card which entitles them to work in television. Actors new to the field who wish to work in television alone will be issued the same 4As card and allowed to work in other fields by taking out a card with the union involved. When a member of one of the existing unions works through the committee, half of his dues will go to his union, half to the committee. When a new member of the committee decides to move to one of the other unions, he will pay the difference between the initiation fee of the committee and the union he wishes to join. All contract negotiations will be conducted by the committee, which is headed by George Heller, National Executive Secretary of AFRA and Alfred Harding, Assistant to the President of Equity.

To establish the committee, each of the five unions has contributed \$5,000. It is expected that revenue from dues and initiation fees will cover expenses after the initial \$25,000 is exhausted.

Possible Problems

From all this, it would appear that all is peace and harmony among the actors' unions. Certainly there is more peace and more harmony than there has or possibly ever will be among the technicians. However, there are still problems which won't be resolved without bitter internecine battles. Some union leaders point out that as television replaces the big nighttime radio shows, AFRA, for example, might begin to feel the pinch of decreased dues payments and ask for

a larger slice of the dues paid to the 4As. The other unions may have similar problems and the ultimate question of jurisdiction is still not settled. Furthermore, there are certain inconsistencies in the plan which will hardly make for completely harmonious relations. It is interesting to note that at the same time the committee was formed in New York, one of the member unions, Screen Actors' Guild, opened contract negotiations with Hollywood producers by asking that televising of films using its members be definitely outlawed.

Despite a handful of problems, the actors' unions have taken an important step in the proper direction. Their decision to apply a little common sense to television is a logical outgrowth of the pattern which unionization of the acting profession has followed over the course of the last thirty years.

Actor's Equity

The first actor's union in the United States was the Actors' Union of America, an affiliate of the AFL, which was formed—but hardly functioned—in 1896. In 1901, the AFL granted a charter to a vaudeville union, the ill-named White Rats Union. (The reason for this absurd title is lost somewhere back in the fog. Alfred Harding, historian of the actors' unions, says that the "Rats" was an inversion of the word "Star," but is at a loss to account for the "White" or the combination of the two.) By 1909, the two groups decided to amalgamate into the White Rats Actors Union, but the organization was smashed, to all intents and purposes, when it struck the Albee vaudeville chain in 1917. In the meanwhile, Actors' Equity Association was formed in 1913 as a younger and more vigorous rival to the White Rats. Equity had no AFL charter at the time, but in 1919, three weeks before the Equity strike for recognition, the by then inoperative White Rats turned their charter over to Equity. The White Rats, however, retained jurisdiction over the vaudeville field through an organization known as the American Artists Federation. The AAF was blacklisted by producers, theater owners and night club operators and never really existed except as a paper organization.

In 1931 the AFL took the Artists' Federation charter and handed it to the 4As, which then meant Equity alone. Equity later chartered, in 1934, the American Federation of Actors, which was supposed to cover performers in vaudeville, night clubs, circuses, etc. Unhappily, the new outfit's leaders decided to play games with Willie Biof and George Browne, the IATSE leaders now serving jail sentences for extortion. Equity had always managed to keep its nose clean and the prospect of seeing the IA's stink-bomb tactics creep into the 4As was too much for the staid and conservative leaders of the grandfather of all the actors' unions. With commendable courage, they revoked the new union's charter and turned it over to the American Guild of Variety Artists.

AGVA

AGVA is a tough, aggressive outfit headed by Matt Shelvey, an ex-performer. It has made a definite contribution to the wages and working conditions of its 48,000 members. However, it too has been accused of racketeering and an undercover group of performers has conducted a vigorous fight against the present administration.

AGVA rates range from \$40 to \$125 a week. In what are known as "DeLuxe" clubs, principals are paid a minimum of \$125 a week, chorus gets \$75. "A" clubs

(Continued on page 39)

THE SALESMEN ARE POLITER

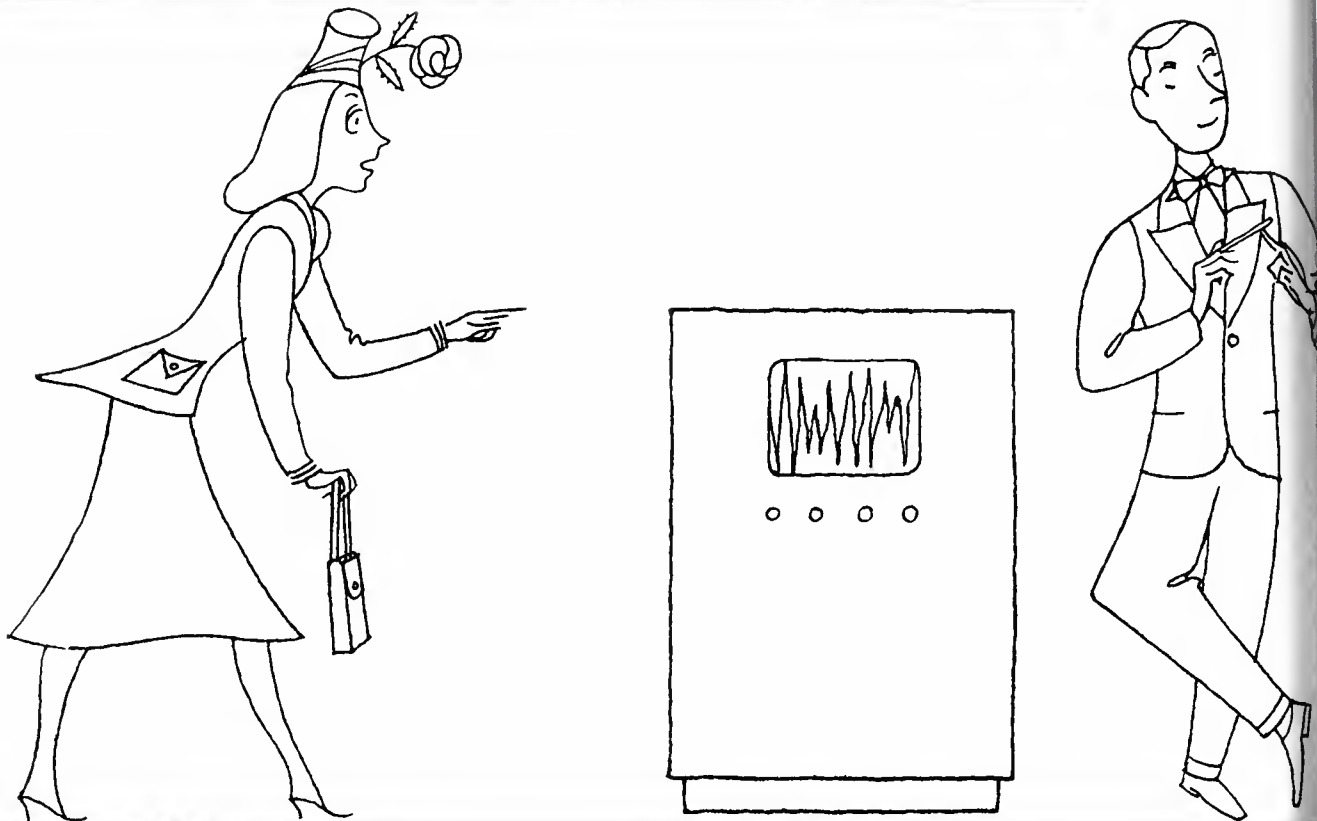

IN THE MIDWEST—BUT

HONEST self-appraisal is very important for the industry. One of the first places to start is by closely analyzing set sales. Even more important is consumer reaction to television—particularly the reaction of the people who *haven't* bought. Following up our shopping report on New York stores in December TELEVISION, we have personally shopped stores in Chicago and St. Louis, watched reaction to demonstration programs, listened to comments, talked to people—not in the trade—but just people who are logical television prospects.

In Chicago and St. Louis, training had undoubtedly been given the salesmen. They were well versed on the price, the features of the RCA service plan, installation, etc.

But . . .

With one station operating in each city, they oversold the idea of network programs; seemed to think that the thirteen channels could be tuned in to New York and Los Angeles when the network went through; gave over-optimistic promises of when new stations would open up.

In only one store was I cautioned to stand back from the receiver and given any information about viewing distances.

In only one store was I given any sales talk on the 7" tube. Naturally a higher priced unit is the one pushed, but it may well be salesman-resistance as well as customer resistance to the small screen size which makes the smaller model a slow moving item. And purse-wise, there must be plenty of people to whom the \$100 difference is the deciding factor in buying now or waiting until later.

Concentrated selling seems aimed at bars and grills—a good promotional factor, no doubt. But advertisers counter that circulation-wise, they don't care about the number of viewers gathered around the sets to watch sports events. They want a home audience.

And most surprising — in both cities, where allotments are small considering the potential — I was promised delivery within a week . . . a factor which might dispute the smug, complacent attitude that demand will continue to far outstrip production.

CHICAGO

In Chicago, I shopped Hudson-Ross, Carson-Pirie-Scott, The Boston Store, Wurlitzers; I observed in Marshall Fields; talked to the buyer at the Fair.

Hudson-Ross

In the Hudson-Ross store on Randolph Street, the 10" RCA model was in the window.

"I'd like to see a television set."
"It's in the window."

"Is that the only one you have. Couldn't I look at one in here?"

"No, that's the only one we have."

"Well I'd like to know something about television. My husband saw one in a bar the other night and he asked me to find out more about it."

"What do you want to know . . . the price?"

"Well we could start there." At which point I got the information, plus the definition of the RCA service plan and year's guarantee, followed by some give and take on programming.

"I would like to see how it operates though before we make up our minds."

"The station is on now—I'll con-

nect the set and you can go outside and look. Better wait about five minutes though—it's cold out and you might as well stay in here." At which point he connected the plug into an outlet inside the store and walked away.

So I strolled outside—to look at a flickering white light on the screen. There was no point in waiting for a picture to appear. I knew the station wasn't on at that particular time anyway. But how many passers-by would know that? Or how many would have thought, "It must be out of order—I guess they have a way to go yet before they get that thing perfected?"

Marshall Field

At Marshall Field, the DuMont \$2495 set was in a living room type enclosure, along with several radio consoles. The RCA 10" set was outside against the wall of the department. Flicker was apparent on both sets, with the picture jumping around. In this case, I decided to be an observer—with both ears wide open to hear comments. An eavesdropper? You bet!

One salesman was leaning against the wall talking to a friend of his, who may or may not have been a prospective customer. Both were looking at the DuMont set. "Look at that picture jump." "Yes—they don't have it perfected yet. You're better off waiting a while. They're high priced too—and that's bound to come down." A few more desultory remarks and the friend left—probably to spread the gospel of "wait."

Another salesman was showing a customer radio-combination consoles. The customer started to watch the DuMont set. The salesman waited — obviously patient. "Television — huh?" . . . "Yes." Pause. The man was standing on top of it, looking down. "The picture looks round—how's that?" "Round tube—the picture is curved as a result." Pause. Then the salesman . . . "Now this radio console . . ." and the customer's interest in television died aborning.

Out by the RCA set, two or three people would come by, stand for a few minutes and then leave. "Don't look so hot to me," said one man to his wife as they walked away.

Boston Store

At the Boston Store, the salesman was doing a pretty good job until I asked:

"Can I get anything out of town?"

"Well if it is something of national importance you will be able to get it. Of course it's pretty expensive. They don't put everything over so you can pick it up. But do you know that we sat right here and saw the Army-Navy game?"

Thinking he may have gotten mixed up in names, I said, "You did? Wasn't that played in Philadelphia?"

"No. It was played in New York—not the Yankee Stadium but that other big place . . . the one connected with Columbia College . . . Baker's Field—that's it."

(For those who don't know, the Army-Navy game was played in Philadelphia, relayed to Washington, New York and Schenectady—but definitely not to Chicago!)

"I'm not sure it would be wise to buy now . . . maybe it would be better to wait until the other stations come on in a few months."

"Well it is expensive (I had not balked at the price!) but if you buy now you won't have to wait for delivery. Once the other stations come on, everyone will want one and you'll probably have to wait a long time. That's the advantage of making up your mind now."

Wurlitzer . . . Carson's

Wurlitzer's salesman did an adequate selling job as did the salesman at Carson's. However at Carson's, there was considerable interference which I was told was due to a diathermy machine being operated in the building but that in the home I would receive excellent reception. I asked—but how about the others, who looked and then walked away without any explanation?

The Fair

At The Fair, it was reported that the 7" model is not selling. While there is no apparent price resistance, customers often feel that there is not enough selection, or expect AM, FM, and combinations. Many customers have no idea of television—think it gives a picture to their radio set and want to know if they can get WMAQ, etc., on their television receivers.

ST. LOUIS

Most common fault in the five stores shopped in St. Louis — Famous-Barr, Stix-Baer & Fuller, Scruggs-Vandervoort & Barney, Aeolian Company and Baldwin Piano Co.—was the overselling done on networks and new stations com-

ing into operation. Patter was so obviously the same that the fault must have originated with one source.

I was told that there would be five stations in St. Louis, with a few more scheduled to open this year. (Five channels have been assigned to St. Louis, but beyond operating station KSD-TV, there are no applications filed for the city.) As for networks, typical comments were that the city would be connected "by the end of the year" or "next year this time from coast to coast." (A. T. & T. estimates by the end of 1948 or shortly thereafter.)

Famous-Barr

At the Famous-Barr, the salesman, who had done a good job up to that point, showed me the thirteen channels and said, "Next year this time, you can tune in on Los Angeles or New York and get any program you want."

Baldwin

At the Baldwin Piano Co. the salesman was exceptionally well-trained. He was the only one who cautioned me to step back from the receiver, telling me what the viewing distance should be. He also pointed out the advantages of the 7" set, saying that it was a matter of preference and giving me the price on it.

Aeolian Co.

At the Aeolian Company, both the 7" and 10" sets were operating at each end of an enclosed space. At first an animated cartoon was on, switching to a film on FDR, with old film clips dating back some 25 years or more included. Set was not adjusted too well to begin with, but as was typical of the older movies, the jumpy action of the people in these sequences was quite apparent.

"Does it usually jump around as much as that?"

"It usually does when they use film."

"That thing would give me a headache to watch." (Again we were standing only about a foot away from the screen.)

There was no vocal answer but what could be construed as an unspoken agreement with my statement.

We watched some more. In silence.

"Are there any other models?"

"No."

"What other stations are on?"

Again the statement that there would be a few more opening up this year.

"Well maybe I better wait until later when there are different models out and the other stations go on." A nod of the head — and again the feeling that he agreed with me.

Stix . . . Vandervoort's

At Stix and Vandervoort's an adequate job was done—except for misconceptions of networks.

Conclusions . . .

Bad displays, poorly adjusted sets and lack of good daytime programming are damaging television; may well stunt its growth unless checked.

Think these questions over:

Is it smart promotion to install a receiver in a window and indiscriminately plug it in? What about ignition interference, glare, adjustment? More important, what about the passers-by who see television—and judge it—under these conditions?

Should receivers be installed—or tuned on—in a store where there is diathermy or other interference?

Why isn't the picture adjusted correctly? Why do salesmen escort the customer up to a 6" viewing distance when a program is on?

The Show's The Thing

And just what do people judge television by? *The program they see on the screen!* If it's dull and uninteresting, if it's poorly produced, if it's bad film—they think, "That's television," not "That was a bad show."

We don't pretend to have made an adequate consumer survey, but we also talked to a few people—people who are not in television, who know nothing about it except what they have seen. Typical of some of the comments we received from "just talking around" are these. They're worth thinking over:

"I only saw television once. My husband and I were passing some local radio shop and they had a set going. Frankly I didn't think so much of it. There was some fellow with a beard talking . . . we got to joking that they had brought Alexander Graham Bell back to life. But seriously, the picture was jumpy and there was no sound—can you get sound with the picture? It reminded us of the old silent movies. I guess technically they have a long way to go yet. We decided we'd just forget about it for a couple of years."

"I've been hearing about television for years but I was certainly

disappointed when I saw it. I hear it's good for sports but I'm not much of a sports fan."

"Television will probably be a wonderful thing some day but I guess it would be better to wait a few years until they improve it. The price is bound to go down too once they get going on it."

Not typical, you say? Don't kid yourself. Get away from the people who are sold on it, who know it's technically perfect. Do some asking and see what you get in reply.

These arguments can be countered by the fact that bars and grills are clamoring for sets—that they claim it's their best business booster; that their places are packed on nights when televised sports are on.

But the people I talked to haven't been in bars and grills. They've seen the demonstration programs mostly. And from what they've seen, they haven't been impelled to stand in line, with money clutched in hand.

No. They're all set to sit back and wait!

DON'T get us wrong. We're sold on television—after all we are the pioneer magazine.

So sold on it that we're going to battle everything that tends to stop its growth.

Washington's T-Week

WASHINGTON'S long-awaited T-Day opened last month with delivery of approximately 800 shiny new television receivers and a blinding rain which drowned out the first ball game of the season and with it elaborate plans to televise the event.

Set Sales

Despite its inauspicious beginning, T-Day and T-Week (April 14-19) chalked up impressive sales with the 65 radio dealers who handled the first sets enthusiastic over their reception by the government workers. Their optimistic predictions place 1,300 tele sets in Washington by next month; another 4,000 by year-end. Southern Wholesalers, Inc., RCA distributor here, estimated that 200,000 people got their first glimpse of television. To help dealers demonstrate their receivers during the daylight hours, the town's only commercial station—DuMont's WTTG—remained on the air for 30 full hours during T-Week, programming from 1:30 to 4 pm daily in addition to its evening schedules. This was a new record for WTTG.

DuMont was given a helping hand by NBC in New York and another television permittee here, the Evening Star station WMAL, which put its drama critic Jay Carmody and cartoonist Dick Mansfield on the television ether.

Only RCA, General Electric and U. S. Television sets were imported for T-Week. Business was most brisk in the lower-priced RCA table models, which retail for \$250 and \$375 respectively plus installation and maintenance costs.

Poor Programs

Generally, dealers' and viewers' reaction was: The pictures are fine but the programs are plain lousy. Dealers frankly pinned their hopes on the sports telecasts and drew the heaviest crowds for the evening fights and the ball games. Some dealers even muffed this opportunity by placing the sets in brightly lighted showrooms and windows where the images were washed out.

Guffaws and groans alike, however, greeted the old-fashioned nickelodeon-quality films which WTTG had to use for filler programs. The moth-eaten Westerns, dull, flickering educational films and short features from the late '30's, were generally panned as doing more than anything else to delay public acceptance of television in Washington. Those few dealers who complained of lagging television sales attributed it to the programs, not the price tags on the sets or the technical quality of the video pictures themselves.—D. H.

TELEVISION RECEIVERS WILL REQUIRE SPECIAL VIEWING FACILITIES

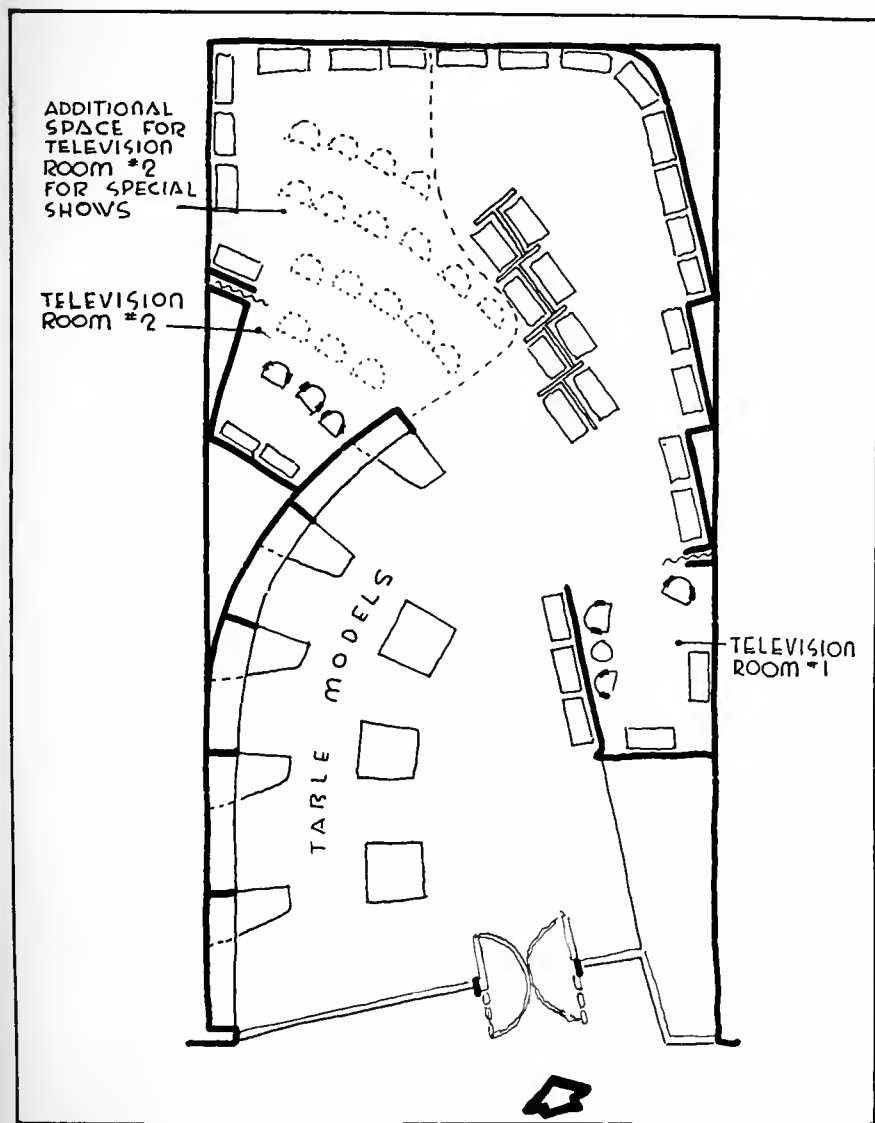

Designed by Morris Lapidus, A. I. A.

With the television receivers of several manufacturers scheduled for distribution within the next few months, the problem of proper store display and merchandising will assume new importance. The old fashioned line-ups of placing sets one after another in a rigid array deprives the customer of a chance to view television under the best conditions.

In the sketch above, Morris Lapidus, A. I. A., has shown a suggested arrangement for a 35'x60' department. This provides

not only for a viewing room but for rapid conversion into a small theatre by use of movable seats and a curtain (shown by the dotted lines) which can be drawn at will on those special occasions when a special group of customers are to be invited for a particular showing.

Furthermore, by arrangement in curves instead of straight lines, the television sets are placed more economically, lending not only more possibility for interesting composition in the displays but actually giving customers a better chance to see them.

A special section for table models is also provided for in this plan. By curving the walls, note that it is possible to get merchandise both in front and behind the wall space within the room itself.

Television viewing room is put in with the dimensions 8'x8' and the little theatre, when expanded, then has a room of 25'x20', enough to accommodate all the customers likely to visit a department or small store at one time.

Lighting in this type of arrangement should parallel as much as possible that of the average home.

While the theatre type construction focuses the attention of the prospective customer on the set, there might be some objection to the too efficient theatrical type of interior in the mind of the person who desires to picture the receiver in home surroundings. This can be offset by having the viewing wall decorated in a manner suggestive of the home interior. Home type chairs and lamps can flank the set, thus creating the "home atmosphere" without losing the attention-focusing advantage of theatre layout.

 Reflections

a regular
monthly feature by
Dr. Alfred Goldsmith

The Ideal Television Receiver

SPECIFYING the character of an "ideal" receiver is as difficult and controversial as describing the "ideal" automobile, camera, or other object of human use. What is ideal to one person may be far from ideal to another, and what is thoroughly satisfactory in 1947 might be amazingly primitive and unsatisfactory ten years later. Further, the conditions and surroundings of the use of an object greatly affect its utility. Again, the length of the purchaser's purse may strongly influence his notion of what constitutes an "ideal" product in any field.

It will probably be objected that the following specifications of an ideal television receiver are in part unreasonable, in part unrealizable, and in any case apparently critical by implication as to the merit of what has been accomplished so far in television receiver production. Nothing is further from the writer's thought. He does not desire to imitate the unreasonable young lady who insisted on purchasing a pair of gloves which were very large inside and very small outside! Nor has he anything but profound admiration for the fine appearance, quality, and performance of some present-day television receivers and a sense of astonishment that in these times of high material and labor costs such complex mechanisms could have been built at all to sell at the prices placed on them.

With this understanding, let us launch into the realm of what one man, at least, believes the television audience will ultimately desire in its receivers. Such a description will at least hint at certain directions in which engineering ingenuity, manufacturing skill, and commercial ability may be further applied.

Woman's Preferences

Inasmuch as the lady of the house, as a general rule, insists on a living room resembling a laboratory as little as possible, it is clear

enough that the television receiver should be an attractive piece of furniture. Some have argued that it should look like a piece of radio equipment. Most people, however, will probably prefer a table or console model which is a handsome addition to the living room furnishings. This will indicate that the operating controls should be thoroughly inconspicuous, or, when not in use, might even be concealed by swinging or sliding doors or the like.

As a corollary, it follows that cabinets must exist in a fair variety of styles in order to fit into diverse home surroundings. The only alternative is to use the style-less cabinet which is of neutral design and jars as little as possible with any surroundings.

There was a time when spacious dwellings were fairly common, but people of this generation are increasingly housed in relatively limited space. Accordingly, everything else being equal, a television receiver should be a compact article of minimum dimensions.

Picture Size

But here we run into a curious contradiction. While it is recognized that many persons will get much enjoyment from television pictures of comparatively small dimensions, yet it is certain that a fair-size television picture (between 7½" by 10" and 12" by 16" approximately) will be desired by most people of average vision and with living rooms of usual dimensions. Pictures are viewed preferably at a distance of about five times the picture width. For the mentioned sizes of picture this would correspond to viewing between 4 and 7 feet from the picture—a range of distance not out of keeping with most living room dimensions.

However, it is a difficult proposition to produce a picture of such dimensions in a really small cabinet. With direct-vision tubes the cabinet which houses them naturally

becomes fairly large. With projection types of receivers, the screen may be housed in the cabinet and, since its dimensions are considerable, the cabinet can hardly be small.

It may prove possible to use projection receivers with screens of special nature mounted on the wall or on a stand near the receiver, on which screen the picture is projected. While this enables a smaller receiver cabinet to be used, it does mean having a screen visible on the wall or on a stand and either removed, rolled up, or otherwise gotten out of the way between times.

Easy Use Features

There are many other obvious requirements of the "ideal" television receiver. It must be simple to select a station, easy to adjust the brightness and other characteristics of a picture, and simple to maintain the set in perfect operation. Then too, the necessity for frequent re-tuning will not add to the pleasure of its owner. Nor should unduly delicate or critical adjustment be required.

It would, of course, be most pleasant if all television receivers could work on an indoor or even a self-enclosed aerial, or at least on an aerial which could be placed in the living room in an inconspicuous fashion. This would enable simple and inexpensive installation and would also avoid many problems connected with outside aerial installation. As matters stand, however, it looks like a difficult if not impossible technical job to handle television reception in all locations by means of indoor aerials.

Price

After laying down all of the preceding specifications it is natural to feel apologetic in suggesting that the price of the receiver shall be quite moderate. This is truly asking limousine performance at runabout prices! Still, from the viewpoint of the manufacturer and the broadcaster alike, as well as that of the public, receivers selling at acceptable figures are most desirable.

(Continued on page 35)

ADVERTISING

Kraft, Swift, Kelvinator to debut in May on WNBT . . . 36 advertisers on in April.

KRAFT

Hour dramatic series to start on WNBT, May 7th

Kraft will make their tele debut in the 7:30 to 8:30 spot on Wednesday, May 7th over WNBT, with "Double Door" as the opener and "Merton of the Movies" skedded for the second show. All plays will be three-acts, cut to fit the hour slot. Program will not be confined to any given type of play, as plans call for using originals, adapting stories and novels, etc.

Product plugged will be MacLaren's Imperial Cheese, a connoisseur's item. Commercial will follow first and second acts, and while live commercial will be used, it will not be dramatized. Agency feeling is that "it would be gilding the lily" to have dramatized commercials with a dramatic show. However some action will be put in and cheese will be shown in an attractive setting. Ed Rice is the agency writer; Mr. Quinn, the producer. Agency is J. Walter Thompson.

SWIFT & COMPANY

1 to 1:30 Friday program debuts on WNBT, May 16th

"Swift's Home Service Show" will star Jinx Falkenberg and Tex McCrary in a half-hour mixture of entertainment and home service. Guests from home making fields will appear as well as entertainment personalities. Emphasis however will be on the better homes angle. Swift has sewed up the exclusive daytime tele rights to Jinx and Tex. Agency is McCann-Erickson. Tom Hutchinson will produce.

BORDEN COMPANY

New Borden's series which started in March over WNBT is designed to give the agency, Kenyon & Eckhardt, a chance to experiment with integrating different types of commercials into various formats. Averaging semi-monthly presenta-

tions, series so far has included the one-act comedy, "The Florist Shop"; film, "Swiss Family Robinson"; public service program in cooperation with Boys Club Week, and, at presstime, Shakespeare's "Twelfth Night," presented in modernized Elizabethan dress and including five different sets. Product being plugged is the new "Lady Borden Ice Cream."

In the Boys Club program, opener showed the boys grouped around the emcee in the studio, then switched to a camp scene with the youngsters singing around the campfire as their grub cooked. Commercial was introduced with distribution of Lady Borden ice cream and a close-up of a youngster's satisfied face as he ate it. Then back to the first set, for an interview with the Dubuque, Iowa teen-ager who was voted the outstanding Boys Club member, some more songs, a feather-weight bout between two eight-year-olds, and the appearance of a Dodger player who had belonged to the Boys Club. Then into the commer-

cial again, showing a large carton of Lady Borden's being sealed and addressed to the Boys Club, followed by the distribution of the individual cartons to the boys. At the end, a film clip of a group of boys marching along an open road was shown, switching to individual close-up shots of typical snub-nosed, freckled-faced youngsters, with a plea to support the organization. Program was good, only criticism being that both commercials were similar.

U. S. RUBBER

Weekly fifteen minute "Campus Hoop-la" (NBC package) changes to fit the sport—right now it's baseball with Keds plugged, but it will shortly switch over to golf with golf balls getting the blurb. Well integrated variety-sports show is set in a campus sweet shop, to which the college crowd flocks. Songs are done supposedly to the accompaniment of the "juke box," with per-

Picture below shows the studio set-up at WNBT for the Borden show, "The Florist Shop." Camera Two (left) just shot a slide saying "To You From Borden's." Camera One (lower right) on a movable dolly, is ready to take the dramatic production. Camera Three (right, behind Camera One) is set on Elsie the Cow. Show was first in series put on by Kenyon & Eckhardt.



Below are some scenes from the "Campus Hoop-la" commercial over WNBT. Mickey and Patsy come in carrying bat, ball, glove. They walk up to counter. PATSY: "Boy, that sure was a nifty catch you made for the last out!" MICKEY: "Aw, it was easy!" PATSY: "Well, you couldn't make 'em like THAT last year."



Red comes up on the other side. RED: "What do you two kids know about baseball, anyway?" PATSY: "Are you kidding? I betcha we kin answer any question YOU can think up!" MICKEY: "This Keds booklet we sent for last month has all the dope!" (Mickey pulls out Keds booklet from hip pocket.)

formers singing to the recordings. Big problem on such a program is music clearance and finding the right songs to fit the format, and the right orchestrations for the singers. Sports angle is handled by Coach Clair Bee and NBC tele-sports caster Bob Stanton.

On recent show, three girls entered dressed in rainwear and complaining about the weather. This led into "April Showers," then the camera switched to a close-up leg shot of the three girls sitting on stools and unfastening their "Gay-tees," U. S. Rubber rainproof footwear, while off-screen narration gave the selling points. Another song followed, then conversation switched to baseball with Coach Clair Bee and his guest answering a few questions, followed by a film sequence of the Giant game played that afternoon, and narrated by Bob Stanton. A few more songs and then two roller skating experts appeared and went through their routine.

On a few shows, the Keds booklet carrying sports information has been offered. Agency intends to try offering this consistently in order to gauge the response. Example of this type of commercial, where the booklet rather than the product is plugged, is illustrated in the following script:

Patsy: "Boy, that sure was a nifty catch you made for the last out!" (Mickey and Patsy come in carrying bat, ball, glove. They walk up to counter.)

Mickey: "Aw, it was easy!"

Patsy: "Well, you couldn't make catches like *that* last year!" (Red comes up on other side.)

Red: "What do you two kids know about baseball, anyway?"

Patsy: "Are you kidding? I betcha we kin answer any question *you* can think up!"

Mickey: "This Keds booklet we sent for last month has all the dope!" (Mickey pulls out Keds booklet from hip pocket.)

Red: "Yeah, who wrote it?"

Patsy: "Frankie Frisch, that's who!"

Mickey: "And it's got everything yuh need to know! How to bat, field, pitch, catch—everything!"

Red: "Hmmm . . . sounds good. Where did you get it?"

Patsy: "We wrote to Keds and they mailed it to us *free*."

Mickey: "Go ahead and ask us something."

Red: "Awright! Let's see. Does

your book tell how to tag a runner?"
(Kids leaf through booklet.)

Mickey: "Tell you in a minute! Ah, here it is on page six. When a runner must be tagged, sprint quickly to your base and straddle it. That is, place your feet so that the bag is between them. As you make the catch, drop your gloved hand to the ground in front of the bag. Make the runner slide or run into the ball."

Red: "O.K. O.K. I'm convinced! Sounds like a pretty good deal. Let's see what else this booklet tells." (All three on cameras as they leaf through booklet.)

Announcer: "Frankie Frisch — who is having a homecoming celebration in his honor at the Polo Grounds tomorrow — has indeed written a wonderful booklet for the Keds Sports Department of United States Rubber Company! This booklet on baseball can be yours for the asking—absolutely free. All you do to get it is write a letter or post-card addressed this way: (Slide: Address.)

Keds
NBC Television
30 Rockefeller Plaza
New York

"Easy, isn't it? So send out your request for the Keds booklet tonight. And please remember to include your own full name and address, won't you?"

"Remember, too, that Keds are the athletic shoes that champions wear in all fields of sport. And whether you're eight or eighty, you'll like the comfort and fit you get in Keds!" (Slide: U. S. Keds.)

Keds Cheerleaders: (Pick up Keds cheerleaders.)

"Best for Mama
Best for Papa
Best for the k—i—d—s
Keds! Keds! Keds!"

Producer is Ken Young for Campbell-Ewald Co., director Ernie Collings for NBC, with Sy Frolick of the agency writing the commercials.

KELVINATOR

"In The Kelvinator Kitchen" will begin on Wednesday, May 7th, in the 8:30 to 9 slot over WNBT. Program, featuring Alma Kitchell, will be a "how to do it" format, centering on food. Agency is Geyer, Newell, Ganger, Inc.

May, 1947

GENERAL FOODS

Three formats used in weekly hour program over WNBT

Gaines Dog Food and Birdseye Frozen Foods are the two products plugged in the 8 to 9 General Foods program over WNBT on Thursdays. Gaines leads off in the 8 to 8:30 spot with the adaptation of their radio show, "Juvenile Jury." Show is televised from studio 8G, in order to accommodate a studio audience, with image orthicons used for the pick-up. Five kids form the jury, with the moderator handing them such world shaking problems as "My mother wants me to take a bath every day but I think twice a week is enough," and "I have an allowance of 70¢ but I think it should be \$1." Moderator Jack Barry gives the problems and calls on the youngsters, with the camera catching them in close-up as they answer. Kids' expressions and antics are cute, although at times they appear just a little *too* precocious.

Commercial is given about the half-way mark with a model leading in Gaines' canine guest of the week. Youngsters are asked to guess the breed, with camera switching from the dog to the children. This is followed by a ruler listing the characteristics of that particular breed, and switching to the dog as the model shows how he measures up. Direct commercial follows with two bags of the Gaines products shown and an oral plug given, concluding with a few pieces dropped on the floor for the dog to eat. Child guest then appears, stands in the witness box and presents his problem to the juvenile jury, followed by another general question. Second commercial follows this stunt, with a brief film strip of models parading with show dogs in Rockefeller Plaza, switching to a girl in the studio who picks up the commentary, explains why she buys Gaines for her dog, puts a bowl on the scale, pours in a pound of the dog food, and adds moisture which brings it up to over two pounds. Bags are shown again and nutritional content stressed. Main criticism of the commercials is that they seem over-

Films for Television

Specially Designed

to **PAY THEIR WAY . . .**

Far-seeing advertisers, now extensive users of "radio", are finding that the most effective, the most economical way to break into television is by means of FILMS. Mr. H. G. Christensen, vice-president in charge of our Television Department, will be glad to show you how such films, as planned by Caravel*, can be made to pay their way—and show a profit.

* Back of Caravel is twenty-five years of "know how" in visualizing sales facts in an interesting and entertaining manner.

CARAVEL



FILMS INC.

Telephone CIRCLE 7-6112

730 FIFTH AVE., N. Y.

long, when the not particularly attractive bags are left on the screen for the oral plug. This is followed by another studio question, and an invitation to tune in next week. Closing commercial is a film strip of a dog barking to the command of "Speak for Gaines." Commercials seem to follow each other too quickly in the last half of the program. Agency is Benton & Bowles.

Birdseye Open House, in the 8:30 to 9 slot, combines Harriet Van Horne in the living room with her guest stars and James Beard in the kitchen with the "I Love to Eat" cooking segment. Opening shows a guest book, with the names of the stars and the guests on each turning page. On initial program, each segment was separate with James Beard coming first, followed by the 15-minute Van Horne slot. Now, however, "With Harriet Van Horne in the living room and James Beard in the kitchen," program leads off with Van Horne interviewing a guest against a living room setting, switching to Beard in the kitchen and back to Van Horne, who goes through the paces with the second guest. Switchover was an improvement, as it tied the two segments together and split up the interviews in a neat manner.

Birdseye trademark is used for the opening with direct commercial given by Beard through the use of Birdseye products in the dishes prepared. (Review of format under Programming, page 29.) End commercial shows a turntable on which are several Birdseye specials, with the price tags on them. Originally, recipe card was shown on the screen. Now, however, viewers are

told to write in for the recipe. Agency is Young & Rubicam.

GRIESEDieCK BROTHERS

Three-part contract signed with KSD-TV

Griesedieck has signed with KSD-TV for 42 fifteen minute programs before the home games of the Cardinals; 42 one minute spots following the baseball games, plus a weekly twenty-minute sports news show for 24 weeks.

Pre-game telecast, "Baseball Close-ups," features the sponsor's radio sports team, Harry Caray and Gabby Street, with Stretch Miller, sports commentator. As they discuss the lineup for that day's game, cameras show the players working out before game time. Interviews of the players, press men and ball club managers are conducted from in front of the Cardinal dugout. Opening and closing commercial has been film with live narration and the middle commercial live from a box seat in the ball park. On one such commercial, camera picked up a rabid baseball fan in the box, going through the motions of jumping up and sitting down again, and finally getting into such a frenzy that he smashed the hat of the man sitting next to him. Action was pantomime to offscreen narration which identified him and commented on his actions. Man then turned around and signalled the vendor, bought a bottle of Griesedieck beer and settled down for a long drink. Camera then cut to field sign "First for Thirst" and panned across to frame the Griesedieck panel.

"Sports Close-ups," weekly half-hour studio show, also features Harry and Gabby with sports celebrities invited to demonstrate the particular abilities that brought them fame. Show is illustrated by chalk talks—for example, opening programs demonstrated all the signals used in baseball that are known only to the players and explained the reason for the existence of the minor espionage systems in ball clubs.

Opening and closing commercial is on film, with the middle one live. (However this will also be on film shortly.) Pantomime to offscreen narration and dramatizations have been used to date. One dramatized version showed an informal corner of a living room, set up for a bridge game, with a buffet table set. Hubby and wife checked things over, for it was hubby's boss who was due. One thing missing were the bottles of Griesedieck beer, which were then added. Offscreen announcer took up the plug as the doorbell rang. Agency is Ruthrauff & Ryan.

BEN PULITZER TIES

Film commercial used with half-hour dramatic show

"It Happened in Manhattan," tightly scripted, one act dramatic show, was produced by Bud Gamble and sponsored over WABD by Pulitzer Ties. Lines were good—short and punchy. Lead in showed film clips of New York, wandered over to 10th Avenue to set the place, and then dissolved into a barroom setting. Story concerned Moran's wife and her boy friend, who paid Frenchy to perjure himself in order to send Moran "up the river." Moran's lawyer entered the bar, started telling them that Moran would even the score and then went to work on their fear when a radio flash announced his escape. Drunk, asleep at a corner table, added the note of suspense when the guilty trio, prodded by the lawyer, began to think that he was Moran. Plot built up, with the final camera shot showing the door opening and a man's legs coming into the room. Show was tightly scripted, lines were good, actors well casted. Only two cameras were used, which was responsible for some inadequate camera work at times.

Commercial idea was good. Film was taken of the Easter Parade—a quick identifying shot of the crowds

Image orthicon cameras are used for the pick-up of the "Juvenile Jury" show, sponsored by Gaines Dog Food over WNBT. Agency is Benton & Bowles.



on 5th Avenue, followed by some close-ups of various male personalities, panning down for a good close-up of the Ben Pulitzer tie he was wearing. Patterns came through very well and program, shown on the night following Easter, made commercial treatment timely.

PURITY BAKERIES

All home games of the Cardinals and the Browns in St. Louis are being sponsored by Purity Bakeries over KSD-TV with Tastee Bread, the product plugged. Commercials are mostly live from the park, with the scoreboard, containing the product name, being picked up between innings. Agency is Young & Rubicam.

FORD

Four film commercials shown during circus pick-up

CBS' pick-up of the circus, sponsored by Ford, rated cheers, with the cameras doing a masterly job of picking the high spots of the three ring, action packed "greatest show on earth." Close-ups were used predominately with an occasional long shot to show the distance. No one in the Garden could possibly have seen in such detail the upside down bike pedalling act performed at the top of the Garden; noticed the bulging muscles; the expressions on the artistes' faces. Particularly good shot was the slow, graceful swinging descent of one performer down the rope. Superimposed over the close-up was a long shot to give the perspective of distance. And added thrill was the bear who got loose and the brief pandemonium which broke out until the trainer got him in tow again. Tension created by the high wire acts, the aerialists and other specialties was almost greater than that experienced when sitting in the Garden for on television it was focused in fine detail before you; there were no distracting influences, no place else for your eye to roam.

CBS staff can take a well-deserved bow on this one. And good psychology, in these days when there are so many new owners of television sets and so many first time viewers, was Gil Faires' repeated comments that the lights had gone out in the Garden which accounted for the blank screen; that it was the guide wires

and not lines on the screen in some shots; that the spotlights were responsible for poor contrast but that it would improve in a few minutes—and his caution to leave the set alone.

Four brief film commercials were used during the event—timed so they didn't interfere with the performance. Films were well-done, and put the story over with a minimum of off-screen narration, which was kept brief and factual. Agency is J. Walter Thompson.

Ford has also signed, through the New York office of Paramount, for split sponsorship of the Cubs' home games over WBKB.

WHEATIES

Wheaties commercial, given on their final show over WBKB, involved a family of three, acting in pantomime to off-screen narration. Pointing up the multiple uses of the product, first shot showed the family eating Wheaties at breakfast. This was followed by junior eating some after school, mother reaching for the box at 5:30 and crumbling up the cereal to be used in lieu of bread crumbs; and dad at 11:00 having a bedtime snack in his dressing gown. Close-up of box wound up the commercial. Agency is Knox-Reeves.

GIMBELS

New "Handy Man" series on WPTZ

Fifteen minute program, sponsored by Gimbel's, Philadelphia, features Jack B. Creamer, "The Handy Man," in a combined entertainment - instruction format. Commercial angle is built around post-war home furnishings designed to make housework easier, and will show and describe merchandise in action, with real people, introduced by Creamer, in real situations and doing real things with the products featured.

This same type of commercial was used in the previous Gimbel's series over WPTZ in 1946, and rolled up a 3% sales return with a viewing audience of less than 800. Now with over 4,000 sets in the area, returns will undoubtedly be higher.

AMERICAN STORES

Commercials used in sponsoring the Jamaica Arena attractions over

THE FINEST IN 16 MM. TELEVISION ENTERTAINMENT

FEATURES

Available for Television

WESTERNS

Starring Kermit Maynard

ACTION

MELODRAMAS

Starring Frankie Darro

MUSICAL COMEDIES

Starring Pinkie Tomlin

SYMPHONIC SHORTS

Aida

Rosamunde

Also Documentary and Educational Short Subjects Available for television

Send for our latest catalog of MAJOR COMPANY features, serials and short subjects.

Exclusive
16 MM Distributors

COMMONWEALTH PICTURES CORP.

729 Seventh Avenue, New York 19, N.Y.

WABD by the American stores of Newark and Hollywood—men's apparel stores—are definitely harmful to television. They are purely radio announcements with a few static slides thrown in for visualization. Television advertising undoubtedly will cost more than radio. To warrant this higher cost, advertisers must obtain results and this cannot be done by using radio commercials on television. DuMont should insist upon visual commercials.

GILLETTE

It is impossible to review the Gillette commercials over WNBT without editorializing. We are fully aware of the effect of constant repetition. We understand the principle of the late George Washington Hill's advertising psychology, but at this stage of the game it is a shame not to experiment, not to try to find a more effective method, a method which will utilize television's visual advantages, and by presenting the same old slides night after night, and slides that are not too well done either, Gillette is not being very far-sighted.

HYDE PARK COMMERCIALS

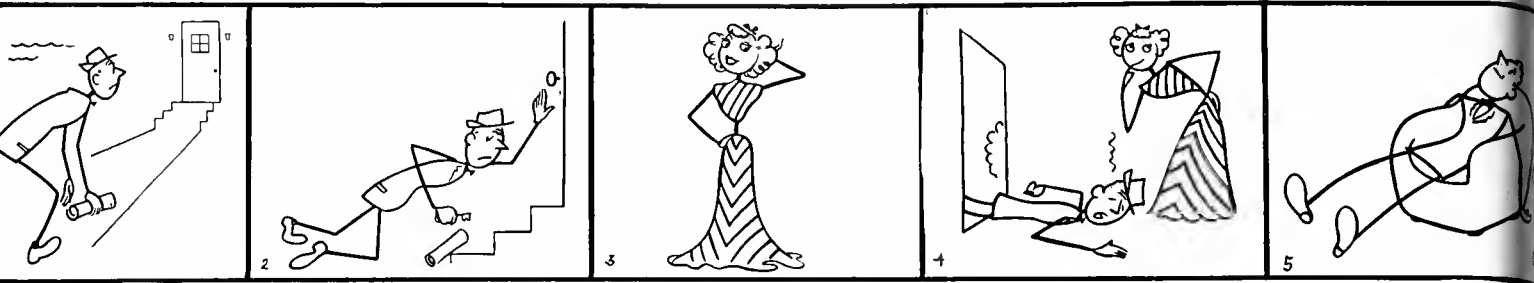

Before we get into the sports business of the evening, let's have a look at one man's answer to the *pleasure* of the evening.

1. Albert, the stick-man, felt pretty low as he wended his weary way home last night. After all, posing all day for a cartoonist can be rather tiring.

2. Truth is, Albert was so *low* he could hardly reach the doorknob as he fumbled for his keys. "Abhh," dreamed Albert,

"For a nice quiet evening at home."

3. Oh! oh! Wifey has *other* plans! Her dinner gown, no less! Plus a big evening at the Mannequin's Ball.

4. Poor Albert just wilted!

5. But Geraldine was a wise wife. She allowed Albert the comfort of his easy chair . . .



6. His pipe . . .

7. And . . . no! no!—not his slippers! That might put him to sleep.

8. Off to the refrigerator she flew and pulled out a tall, frosty bottle of delicious, refreshing Hyde Park True Lager—the beer that's *extra good* because it's *extra aged*.

Next, to the cupboard for a tall, slim glass and . . .

9. Presto! The right combination after a long, hard day!

10. In practically nothing flat, Albert was sipping that sparkling, refreshing Hyde Park Beer. And as he lingered over that extra smooth . . . extra mellow true lager flavor, he made a mental note to try to remember his wife's birthday this year.

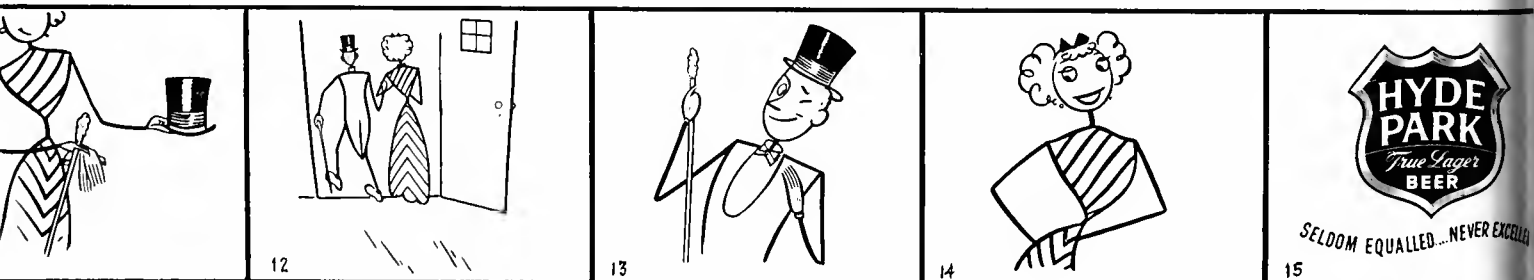

11. Ahh, but Geraldine—as usual—was way ahead of him. Out came top hat, cane and gloves. And you know the rest of the story—

12. Off to the Mannequin's Ball they went—thus ending the

story of Albert the stick-man . . .

13. Geraldine, wise wife . . .

14. And a timely supply of Hyde Park True Lager Beer—the beer that's *extra good* because it's *extra aged*!

HYDE PARK

Sponsors boxing, sports events over KSD-TV, St. Louis

Boxing, wrestling, hockey and professional basketball have been

sponsored by Hyde Park brewery over KSD-TV since opening week. Because station has only two field pick-up cameras, making it impossible to flash back to the studio for commercials, "Albert the Stick-Man" was devised. This whimsical cartoon character forever has a problem and is forever finding the solution in a bottle of "delicious,

extra-aged Hyde Park True Lager Beer." Pick-up is made directly from the television booth at the arena. Shown above is one of the cartoon sequences. Gardner Advertising Company is the agency. Ernie Whitney of the Gardner staff wrote the copy; with art work prepared by the agency's art department.

CURRENT ADVERTISERS ON ALL STATIONS

American Stores—Sponsorship of boxing bouts. Monday and Wednesday. WABD.

Armour Co.—Institutional film. WNBT, one time. Agency, Foote, Cone & Belding.

Atlantic Refining Co.—Alternate sponsorship of Phillies and Athletics baseball games. WPTZ. Agency, N. W. Ayer & Sons.

Bache & Co.—Financial news from INS news ticker. WABD, Friday, 1 p.m.

Benrus—Time signal. WNBT, Friday. Agency, J. D. Tarcher & Co.

Birdseye (General Foods)—Integrated half-hour show featuring "Open House" interview format and "I Love to Eat", cooking show. WNBT, Thursday. Relayed to WPTZ and WRGB. Agency, Young & Rubicam.

Borden Co.—Different formats being tried out about twice a month over WNBT. Agency, Kenyon & Eckhardt.

Botany—Weather reports. WABD, WNBT, KSD-TV, KTLA, WBKB. Agency, Alfred Silberstein, Bert Goldsmith.

Bristol-Myers—"Tele-Varieties." WNBT, Sunday, 8-8:15. Fifteen minute variety show plugging Minit-Rub and Ipana alternate weeks. "Tele-Varieties" now replaced with "At Home with Tex and Jinx", film and live interview format, featuring Tex McCreary and Jinx Falkenburg. Relayed to WPTZ and WRGB. "Bristol-Myers Party Line", WCBS-TV, Sunday, 8:30 to 9. Half-hour audience-viewer participation show, sponsored by Ipana and Vitalis. Agency, Doherty, Clifford and Shenfield.

Bulova—Time spots. WNBT, WCBS-TV. Agency, Biow Co.

Chevrolet—Hour show. Weekly Western film. WABD, Tuesday. Relayed to WTTG. Agency, Campbell-Ewald.

Commonwealth Edison Co.—"Telequizzicals". WBKB, Friday. Half-hour viewer participation show. Split sponsorship of the Cubs games.

Elgin—Time spots. WNBT, WABD, WCBS-TV, WBKB, KTLA. Agency, J. Walter Thompson.

The Fair—"Telechats". WBKB, Friday. Fifteen minute news program.

Firestone Tire & Rubber Co.—"Voice of Firestone". WNBT, Monday. 10-minute film format. Relayed to WRGB and WPTZ. Agency, Sweeney & James.

Ford Motor Co.—"Parade of Sports." All events, except boxing from Madison Square Garden. Split sponsorship of Dodgers over WCBS-TV. Split sponsorship of Cubs over WBKB. Agency, J. Walter Thompson.

Frigidaire—Institutional film. WNBT, one time. Agency, Foote, Cone & Belding.

Gaines Dog Food—(General Foods)—"Juvenile Jury". WNBT, Thursday. Half-hour adaptation of radio program. Relayed to WPTZ and WRGB. Agency, Benton & Bowles.

General Electric—Appliance commercials. WRGB. Spots or in dramatized formats.

Gillette Safety Razor Co.—"Cavalcade of Sports". WNBT, Monday and Friday. Boxing bouts. Relayed to WRGB and WPTZ. Agency, Maxon, Inc.

Gimbels—"The Handy Man". WPTZ, Friday. Fifteen minute merchandise demonstration program.

Griesedieck Brothers Brewery—Fifteen minute program preceding and one minute spot following home games of Cards. Weekly twenty minute sports' news show. KSD-TV. Agency, Ruthrauff & Ryan.

Gruen—Time shots. WCBS-TV. Agency, McCann Erickson.

Gulf Refining Company—"Television News." WCBS-TV, Thursday. Fifteen minute live and film program. "You Are An Artist." WNBT, Thursday. Fifteen minute art lesson format. Relayed to WRGB and WPTZ. Agency, Young & Rubicam.

Hyde Park Breweries Association, Inc.—Boxing, wrestling, sports. KSD-TV. Agency, Gardner Advertising Co.

Longines-Wittnauer—Time spots. WABD. Agency, Arthur Rosenberg Co.

Philadelphia Electric Co.—"Television Matinee". WPTZ, Monday, Wednesday, Friday, 2 to 3. Three-part hour show with two live segments on food preparation and fashions, etc. and one on film.

Philco Distributors, Inc.—Alternate sponsorship of Phillies and Athletics baseball games. WPTZ.

Post Toasties (General Foods)—Split sponsorship of Dodgers games over WCBS-TV.

Purity Bakeries—Home games of Cards and Browns. KSD-TV. Agency, Young & Rubicam.

RCA Victor—"World in Your Home". WNBT, Friday night. Fifteen minute film program. Relayed to WRGB. Agency, J. Walter Thompson.

Reid's Ice Cream—Weather reports. WCBS-TV, Thursday and Sunday. Agency, Doherty, Clifford and Shenfield.

Sears-Roebuck—"Visi-Quiz". WPTZ, Thursday. Half-hour audience viewer participation program. Agency, Ray Nelson.

Standard Oil of New Jersey (Esso)—"Television Newsreel", WNBT, Monday night. Relayed to WPTZ. 10 minutes of late news films. Agency, Marschalk & Pratt.

U. S. Rubber Co.—"Serving Through Science". WABD, Tuesday. Half hour film program. Relayed to WTTG. "Campus Hoopla". WNBT, Friday. Fifteen minute variety-sports show. Relayed to WRGB and WPTZ. Agency, Campbell-Ewald.

Wanamaker's Department Store—"Wanamaker Presents." WABD, Wednesday. Half hour shopping, merchandise program, presented in cooperation with various manufacturers.

Station Line-Up

WNBT: Armour, Benrus, Birdseye, Botany, Bristol-Myers, Bulova, Elgin, Firestone, Frigidaire, Gaines Dog Food, Gillette, Gulf, RCA Victor, Standard Oil of New Jersey (Esso), U. S. Rubber.

WCBS-TV: Bristol-Myers, Bulova, Elgin, Ford, Gruen, Gulf, Post Toasties, Reid's Ice Cream.

WABD: American Stores, Bache & Co., Botany, Chevrolet, Elgin, Longines Wittnauer, Alexander Smith, U. S. Rubber, Wanamakers.

WPTZ: Atlantic Refining Co., Gimbels, Philco Distributors, Philadelphia Electric Co., Sears Roebuck.

KSD-TV: Botany, Griesedieck Brothers, Hyde Park Brewery, Purity Bakeries.

KTLA: Botany, Elgin.

WBKB: Botany, Commonwealth Edison, Elgin, The Fair, Ford.

FILMS

Partial list of film releases for television.

Printed below is a partial list of film companies who have releases available for television rental. In response to a questionnaire sent out by TELEVISION, all have indicated their willingness to sign the following release:

"We warrant that we have the right to grant this license and agree to indemnify you against liability, loss or damage, including attorney's fees, arising out of or caused by any matter contained in the film or use thereof and, upon request to defend at our own expense, any suit based upon any matter contained in the film or the use thereof as herein contemplated."

Because of the need for this information, we are constantly surveying the field, and other listings will appear in forthcoming issues.

Advance Television Picture Service Inc., 729 7th Avenue, N. Y.—Charles A. Alicoate. 16mm., 35mm. Educational, documentaries, features, shorts, serials.

Association Films, 347 Madison Avenue, N. Y.—W. C. Adrian. 16 mm. Sports, features.

Award Films, 115 W. 44th Street, N. Y.—Roslyn Appelbaum. 16 mm. Educational, documentaries, cartoons, features, shorts.

Bailey Films, Inc., 2044 N. Berendo, Hollywood 27, Calif.—Albert R. Bailey, 16 mm. Educational, documentaries, cartoons, shorts.

Brandon Films, Inc., 1600 Broadway, N. Y.—Thomas J. Brandon. 16 mm., 35 mm. Educational, documentaries, shorts.

Capital Pictures Corp., 723 Seventh Avenue, N. Y.—W. Pizor.

Commonwealth Pictures Corp., 729 7th Avenue, N. Y.—J. Hyams. 16 mm. Features, shorts, documentaries, educational.

Dudley Pictures Corporation, 9908 Santa Monica Blvd., Beverly Hills, Calif. 16 mm. Educational, documentaries, shorts.

Equity Film Exchanges, Inc., 341 W. 44th Street, N. Y.—Myron Mills. 16 mm., 35 mm. Features, shorts.

Franco-American Film Corporation, 1 West 64th Street, N. Y.—A. T. Kaplan. 35 mm. Documentaries, features in French, English titles.

Guaranteed Pictures Co., Inc., 729 Seventh Avenue, N. Y.—M. D. Sackett. 16 mm., 35 mm. Educational, documentaries, features, shorts.

Hoffberg Productions, Inc., 620 Ninth Avenue, N. Y.—J. H. Hoffberg. 35 mm. Educational, documentaries, features, shorts, foreign language films with English titles.

International Film Foundation, Inc., 1600 Broadway, N. Y.—Julien Bryan. 16 mm., 35 mm. Documentaries.

Knowledge Builders, 625 Madison Avenue, N. Y.—Robert R. McCrory. 16 mm., 35 mm. Educational, documentaries.

Modern Film Corporation, 729 Seventh Avenue, N. Y.—Sally Dorf. 35 mm. Features.

**no platitudes
no rosy prophecies
just solid fact**

**every month, TELEVISION
magazine will bring you a full
report on all significant developments
in the industry whether
it be FCC actions, advertising,
equipment news, programming,
station operation, films, etc.**

**\$4.00 for a year's subscription
send in the attached card today**

Nu-Art Films, Inc., 145 W. 45th Street, N. Y.—G. W. Hedwig. 16 mm., 35 mm. Comedies, drama, novelties, educational, features.

Official Films Inc., 25 W. 45th Street, N. Y.—Robert Wormhoudt. 16 mm. Educational, documentaries, cartoons, shorts, sports, musicals.

Popular Science Pub. Co., Audio Visual Division, 353 Fourth Avenue, N. Y.—James M. Goodsell. 35 mm. Educational.

Post Pictures Corp., 723 Seventh Avenue, N. Y.—David B. Dash. 16 mm. Educational, features, shorts, travel, sports.

RKO Television, 625 Madison Avenue, N. Y.—Ralph Austrian. Telereel series.

Simmel-Meservey, 321 S. Beverly Drive, Beverly Hills, Calif.—Douglas Meservey. 16 mm. Educational, documentaries.

Swank Motion Pictures, Inc., 614 N. Skinker Blvd., St. Louis, Mo.—P. Ray Swank. 16 mm. Educational, documentaries, shorts.

Toddy Pictures Co., 723 Seventh Avenue, N. Y.—Ted Toddy. 16 mm, 35 mm. Educational, documentaries, features, shorts. (All are with Negro actors, bands, etc.)

Young America Films, Inc., 18 East 41st Street, N. Y.—T. C. Morehouse, Jr. 16 mm. Educational.

Some companies, while signifying their willingness to rent films for television, feel that the release quoted above is too general. Two firms in that category are:

A. F. Films, 1600 Broadway, N. Y.—Rosalind Kossoff. 16 mm. Educational, documentaries, shorts.

Gallagher Films, 113 S. Washington, Green Bay, Wisc. — J. C. Gallagher. 16 mm. Educational, documentaries, cartoons, features, shorts, sport films.

PROGRAMMING

Analysis of NBC and CBS programming . . . baseball coverage . . . reviews of recent formats.

PRACTICALLY all operating stations have demonstrated that they are capable of producing top professional television entertainment. However, with the limited budgets the stations are now working with, there is very little consistency in quality, and for every good show there are many more bad ones produced.

This is nowhere better illustrated than in the programming of CBS and NBC. Although a small percentage of their shows can rival the best in any other informative or entertainment medium, with their limited budgets (many another station would not exactly call them limited) there is still a severe limitation on their programming output.

This should all point to the desperate need for the development of low cost shows. With the exception of sport pickups, the local stations will have an almost impossible task, until there is nation-wide network facilities.

From time to time, good low budget shows have cropped up. Television needs more of them.

LOW BUDGET SHOWS

"You Are An Artist"
—"I Love to Eat"—
"Party Line".

The NBC-Gulf *"You're An Artist"* program embodies all the ingredients to make the FCC, the audience, the station and sponsor, happy. It's educational, entertaining, and should be possible to produce locally at a very reasonable cost.

Show is built around John Gnagy, personable artist, who takes a subject like abstract art and explains it by crayon sketches. The sketches are kept very simple, so that they are not only very clear, but enable the audience, if they are so inclined, to sketch while watching the program. In the abstract art show, Gnagy used a bowl of fruit for his subject. By sketching the fruit bowl from three different angles, and then taking elements from each

sketch, he was able to show the audience how abstract art is conceived. In spite of the seemingly limited appeal of this type of program, because of the light patten of Gnagy, the audience is practically unlimited.

"I Love to Eat"—Cooking shows which consist of cook and kitchen obviously can be produced within the most limited of budgets. NBC has built their *"I Love to Eat"* show, which is now sponsored by Birdseye, around James Beard, famed gourmet and author of many books on the culinary arts. Program at times is quite interesting and informative for the housewife who's trying to perk up "the same old dishes." Beard usually comes through with an unusual twist for the regular recipes. Program shows preparation and cooking of either a dinner or some specialty, such as pot au feu, or a particular dessert or dressing.

Main trouble now is that Beard has to spread his chatter too thin to fill in the time while he washes the dishes or prepares two artichokes rather than one. There seems to be

Left: CBS tied up fashions with ballet touch in a recent program. Male dancer dressed as handy man opened show by dusting off hat boxes with models popping out, and then kept reappearing to change the models' positions, etc. Right: College campus styles were demonstrated over WNBT, with a straight fashion show approach used in campus setting.



no reason why these unnecessary steps can not be cut out. If they were, Beard as well as the program would seem much sprightlier. An obvious and important factor, not always kept in mind on the show is the utilization of television's visual advantages.

CBS in their cooking show, "*Come Into the Kitchen*," with Heloise Parker Broeg, usually pick a culinary subject in which visual instruction is necessary. On one of their stanzas, lesson for the day was how to make buttercups. The trick is in the proper placing of the bread in the muffin pans. This was clearly demonstrated, and might not have been grasped over radio at all. On another show, Mrs. Broeg showed how to cook a live lobster, how to kill it, where the spine had to be severed, and so forth, all of which would have been difficult to describe adequately over radio.

CBS sticks to the straight woman in the kitchen cooking show, with no fancy frills, whereas NBC takes a well-known figure and builds a show around him. Both methods are satisfactory. It would seem, though, that a surer and safer guarantee of a good cooking program would be to play it straight.

Another low cost show is CBS' successful "*Party Line*." Particularly interesting is the job CBS has

done on John Reed King, the emcee. King, a pioneer television programmer, at first used the same approach and personality in television as he has on his radio show, "*The Mrs. Goes A-Shopping*." Result wasn't too good. His radio personality was too noisy, too buoyant, too hammy for television, although it is successful on the radio. You just can't overact on television. CBS gradually tamed him down till King's new tele-personality fits in successfully. (However, now Bert Parks is taking over.)

Format of "*Party Line*" is viewer participation via telephone in solving charades, rebuses, and so forth. Rebuses, riddles expressed by a combination of words and pictures, are perfect for television, and stimulate an active interest upon the part of the viewer. Charade allows for element of comedy. Show is sponsored by Bristol-Myers through Doherty, Clifford and Shenfield.

VARIETY AND FASHION

CBS and NBC approach differs on these two formats

Vaudeville as we knew it back in the 20's is dead. A series of unrelated acts seems to miss the boat.

It just doesn't catch the modern tempo.

Most showmen have always realized this. Perhaps that is why the revue formula was developed, for here it is possible to keep the variety of vaudeville but to give some form and unity to the program.

CBS has done very well at tying up and skillfully blending the unrelated vaudeville acts. The clever use of music and at times a dancer, has successfully turned what would have been vaudeville into a revue. When an emcee is used, CBS manages to keep away from the stereotyped show by using only a few acts, and having them repeated during the show. For example, CBS variety show will open with a short song by a vocalist. The same vocalist will probably appear again in the middle of the show, and again at the end. If a dance team is also on the show, they will also probably appear at least once again. This definitely gives a feeling of continuity to their variety programs.

NBC, on the other hand, who in most cases have had superior individual acts, have not been as successful in tying up their variety shows. Perhaps they still prefer vaudeville. In their recent "*Show-Business*" series, the program offered to replace the "*Hour Glass*" show, the format consisted of father and daughter running a talent agency. The auditioning of new acts, and the byplay of pros and cons by father and daughter served as the bridge between acts. It just didn't work out, though; it was artificial, and the results were still vaudeville.

The problem for programmers is not only to get good acts, but, just as important, to tie them together skillfully, and this can be done quite simply, as CBS has demonstrated.

Fashion Show Techniques

A good opportunity to evaluate television fashion shows was presented recently, with both CBS and NBC using different approaches. CBS pretty much stuck to the same artistic approach that they used in their variety shows, and tied up their fashion presentation effectively by a ballet touch, by skillfully blending music with usually just one dancer. For example, one CBS show opened on an excellent setting of hatboxes, with a male ballet dancer dusting off the boxes,

WNBT's tele-version of the Broadway play, "*Little Brown Jug*" was very well done. Story concerned a psychopathic handyman who attempts by blackmail to dominate the lives of a woman and her daughter. Director was Ernie Collings.



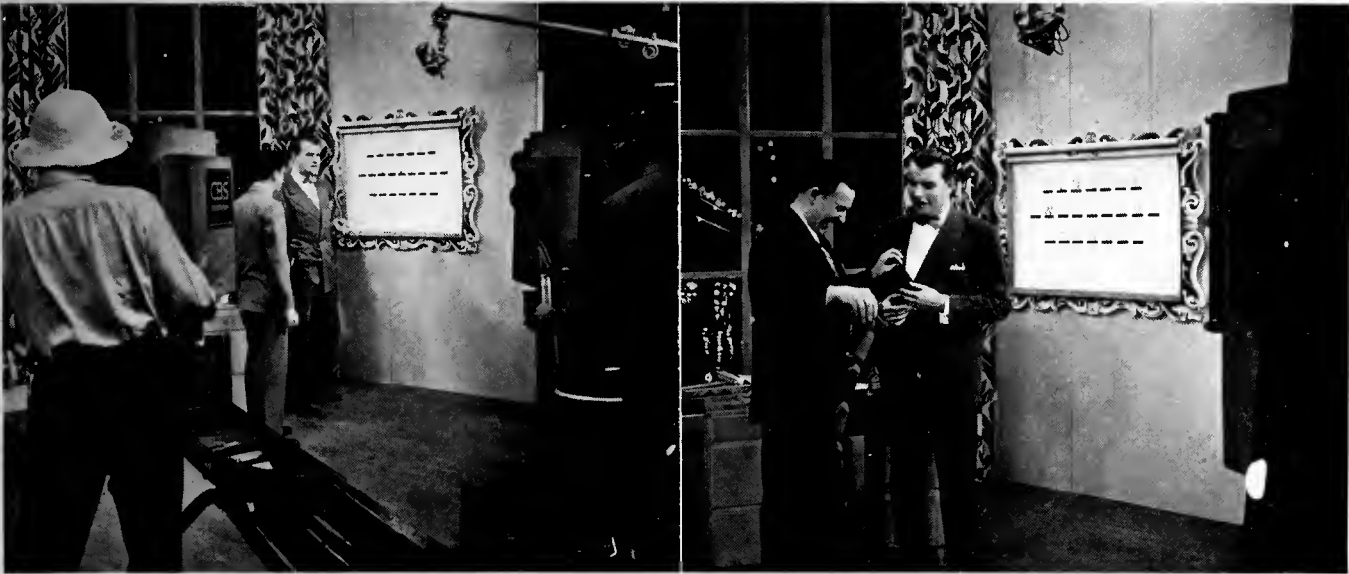

Rebuses, word games, etc., all help visualize the low-cost audience participation shows. Shots above are from the John Reed King "Party Line," sponsored by Bristol-Myers over WCBS-TV. In chart at left, a few letters are indicated in some spaces—such as i, n—a on the first line. Contestant has the problem of taking the word star and by using the letters in it, fill in the blanks. (Sinatra). Picture at right shows the completed problem. Agency is Doherty, Clifford & Shenfield.

and from time to time opening a box, with the expected model popping out of it. Dancer would reappear and lead the models about, change their positions, etc. Artistically, CBS' fashion shows were quite pleasing, although perhaps a merchandiser might complain that there was too much ballet and not enough fashion. NBC built their program on a more solid base. On one show, they had outstanding designers, such as Jo Copland, the John part of John Frederics.

A sketch of each of the designers' creations came to life and then was discussed by the designer. For a straight fashion show, this format has unlimited possibilities, and would seem to be more informative to the fashion-conscious woman. Unfortunately, the execution did not live up to the idea. Unnecessary attempt at lightening up show by interjecting and not blending irrelevant acts, such as a magician, a dance team, and so forth, merely served to interrupt and to confuse. Perhaps most important thing that could be learned from this particular NBC show is that the success of it is entirely dependent on the ability of the femcee.

In this particular case, Maggie McNellis of cafe society fame was the femcee. While Miss McNellis is well-liked, and considered a capable performer in these circles, she was obviously not suited to her task. She lacked the lively patter and the necessary personality to put her guests at ease.

With the right execution, the NBC approach would seem to have greater appeal to women. However, if the eventual sponsor is also interested in the male audience, the CBS show might have more appeal.

DRAMA

Given a good script and capable actors, there are producers around to provide topnotch television drama. Capable actors are available, good original scripts are not. Adaptations seem to be the best answer, but here the clearance of plays and the time spent in the adaptation, etc., run these costs in most cases outside of budget limits. Consequently the average dramatic fare is below par. Perhaps it would be better for television to forego dramatic production unless top scripts are available, for television will only suffer in comparison to other media when mediocre productions are televised.

CBS put on a well-staged and acted play, "Too Little to Live On" recently.

Four actors and two sets were used. For a half-hour program, it could be called low-budget. Cost was somewhere around \$300. It wasn't bad, but it just couldn't stand up to Hollywood or the Broadway theatre, and this was largely due to the inadequate script.

The same applies to NBC's recent

"An Orchid for Margaret." Here we had a light, juvenile play about young love in the Spring. The acting wasn't bad, the script wasn't good, the direction was indifferent. There are certain things which television can do well, and which show up to particular advantage over television. They capture television's very uniqueness. Putting on fourth-rate dramatic productions is a step in the wrong direction. There are exceptions, like the excellent job on Shakespeare's "Twelfth Night," sponsored by Borden over WNBT. (Agency is Kenyon & Eckhardt).

BATTER UP

No set formula for camera placement at baseball games

Stations are still experimenting with camera positions for telecasting the baseball games. Some have already shifted the locations. At the present time:

CBS, for the Dodgers' games at Ebbetts Field, uses two cameras in a booth behind home plate, and signal is relayed by RCA link transmitter to the Chrysler Building in Manhattan.

DuMont, at the Yankee Stadium, uses three image orthicons between home and first base. DuMont also uses the RCA link transmitter to send a signal to its main transmitter at 515 Madison Avenue.

WCBS-TV cameras televise the Dodgers games from a booth behind home plate. Cameras are protected by shatter-proof plexiglass window. Games are sponsored alternately by Ford and Post Toasties (General Foods).



Irving Crane, world's pocket billiard champion, demonstrated several different games of pool as well as some difficult trick shots over WRGB, Schenectady.

NBC, in televising the Giants at the Polo Grounds, uses three cameras, one behind home plate and two along the first base line.

KSD-TV televises the Cardinals' and Browns' games with two image orthicon cameras. They are located on a small balcony which projects out from the balcony of the grandstand itself, and is about four feet below it. This location is about one-third the distance between home plate and the first base. The viewing angle is such that with a 50 mm. lens, the camera takes in the pitcher's box, and the batter, the catcher, and umpire. Again, an RCA micro-wave relay link sends

the signal to the main transmitter. The transmitter is located on the roof of the grandstand, and its four-foot parabolic reflector pointed at a similar installation on the roof of the Post-Dispatch Building two and a half miles away.

WPTZ, in telecasting the Athletics and Phillies in Shibe Park, use two cameras, just to the right of the home plate. One camera extends from the first balcony and the other is at the top of the stadium. Signal is radio-relayed to the main transmitter.

WBKB, for the Chicago Cub games, uses two cameras between home and third, and here too the

signal is sent by radio relay to the main transmitter.

KTLLA uses three cameras for their pick-ups of the Los Angeles and Hollywood teams. Camera one is located twenty feet behind catcher, slightly sighted to eliminate umpire blocking play. Second camera is off first base for outfield action, with the third camera used for occasional closeups of ball catching in outfield, etc. Signal is relayed directly to Mt. Wilson.

WWDT signed with the Detroit Tigers for two telecasts a week beginning in June.

CHILDREN'S SHOW

"Small Fry Club" regular WABD children's show

"The Small Fry Club," an effective kiddie show produced and emceed by Bob Emory, DuMont program manager, originally started out as a weekly hour show but has now switched to half-hour segments on Tuesdays and Thursdays at 7.

Format consists of Bob Emory enacting the role of Big Brother to the kiddie audience. Patter is based on information received from the little viewers' parents. In the course of the show, Bob will mention names of viewers, urge them to drink more milk or compliment them on their school grades, etc. Usually two film shorts are shown. Effort is made to have one cartoon and one film, like the recent show which was produced by Young America films, on reasons for daily chores. They have already lined up old Shirley Temple, Charlie Chaplin and other pictures suitable for the young audience.

Slides are also used of pictures sent in by the junior audience. Regular membership card is sent to all viewers requesting them. To date, Small Fry Club has more than 1200 members.

Because of the attraction of the Small Fry for television, announcement is made at the end of the program, "That's all for tonight. Now it's time for small fry to get to bed." Experience has shown that this announcement will not itself get the children away from the set, so announcer is kept on for minute or two, rather than going straight into evening show.

The show sounds corny and is corny, but the children like it. Its very informality makes the kiddies

feel that they're in on "something." Only problem is in obtaining suitable films. Balance of show is quite simple. It's all master-controlled, and no studio crew is necessary. For even Bob Emory doesn't appear on the screen. His talk is illustrated by slides, etc.

WRGB EXPERIMENT

One camera used on one-set show

WRGB's "The Pay-off," original fifteen minute drama written by staffer Ted Beebe, was done with only one camera. One set show had three people in the cast. Larry Algeo, WRGB producer, did it as an experiment for he felt that a certain visual continuity and fluidity might be achieved with one camera which couldn't be captured otherwise. From his observations, cuts often seemed to disrupt continuity, confusing the placement of objects and performers to the viewer and giving him momentary shocks—as, for example, when cutting from a long two-shot from a camera on one side of the set to a closeup of a performer from a camera on the other side.

To quote Larry Algeo: "My problems in direction were a little more difficult than it would seem at first glance. It would have been simple to hold one fairly long shot most of the time, having the characters walk into the picture, sit down, then get up and walk out. But that is exactly what I didn't wish. I wanted variety — lots of camera and performer motion. I wanted people to walk all over the set; I wanted long shots, medium shots and closeups. I got them, but it took as much or more pre-planning than if I had used two or three cameras.

"Striving to physically motivate every pan or dolly, I think I succeeded in every case but one; and out of the various times that I had a single shot of one character and another spoke a line or two off camera, no one missed seeing the other character except in one or two cases. In other words, the vast majority of the time people saw what they should have seen, what they wanted to see."

From voluntary comments or from questioning of normal viewers, other WRGB directors and technical people, conclusions drawn



WABD's "Small Fry" program now lists over 1200 little fans who have written in for the membership card.

were: Average viewers didn't notice the fact that only one camera was employed. Two directors, having known the fact previously, said that they soon forgot about it while watching the show. It was generally conceded that the program seemed much easier on the eyes than one in which there are many cuts; moreover, that watching the show as if one were standing in the center of the room all the time made for exceptionally good orientation. The "fluidity" angle was pointed up particularly by the technical gang.

What was proved by the experiment? Most of the WRGB staffers reached the conclusion: The number of shows which can be done effectively on only one camera is very small. However, in multiple-set shows with many brief scenes, there is little need to move two or three cameras to each set when one camera might do the job as effectively with proper direction. Moreover, in most instances whether the show has one or eight sets, more is sometimes gained by having one camera on the air longer and keeping it and/or the actors moving than by taking a lot of needless and sometimes annoying cuts.

REMOTES

Sub and museum telecasts point up educational angles

Perhaps one of the most important telecasts ever to come over a television receiver was NBC's recent televising of a submarine in action. No show, with the possible exception of the President's appearances over television, could better show the tremendous and powerful potential in television as a medium of information and education. The quality of this telecast can rival that of some of the finest docu-

mentary films. But it had something else—something which only television can give—a spontaneity, an immediacy and closeness. Three cameras were used; one at the dock, for an overall picture of the submarine, and its submersion; while the others were inside the sub. Not only was every detail, from the control room to the galley, clearly shown to the televiewer, but more important, the men who make the submarine tick, were caught by the television cameras under actual working conditions, performing their various tasks. It was as if the televiewer was in the submarine speaking to them personally. There were no dramatic shots, no special posing. Television caught what Louis de Rochemont of March of Time fame, and other documentary producers strive for but can never really obtain. Television caught the real thing, the submarine and the men as they were. If there are still any skeptics as to television's force as an advertising medium, they should have seen this show, for an advertising medium is only as strong as the program medium.

Another great television show was the televising of the circus by



FILMS FOR TELEVISION

Bring first class comedies, dramas, novelties and many educational subjects to the television screen.

35 MM & 16 MM PRINTS of the highest laboratory quality are kept in perfect condition for televising at any time.

A FILM FOR EVERY PROGRAM

Sponsored programs find great tie-in values in our subjects.

SEND NOW FOR:

Film lists and complete data on available subjects to:

TELEVISION DEPARTMENT





New "Pleased to Meet You" series over WPTZ features celebrities from the theatrical, operatic or Hollywood world who come to Philadelphia. Above, Vivian Della Chiesa, noted opera star (center), with Rhona Lloyd and Jim Ameche, makes her television debut. Jose Ferrar has also appeared on show.

CBS. (Review under Ford, page 25.)

WBKB's weekly pick-ups from the Museum of Science and Industry have proved highly informative and have been well staged. Museum is a natural for such programming, with its replicas of model homes, industries, farms, and scientific exhibits. Skilled workmen and museum guides who, as part of their

daily job, explain the various projects to the visitors are used on the telecast, plus an mc who interviews them. However, it just isn't a case of going in and doing it — show must be carefully pre-planned with Beulah Zachary, WBKB producer, going out to the museum a few days before and lining up the show. Day of the telecast, remote crew gets there about three hours before show

Puppet orchestra, operated by Joseph Owen, his wife, his son Joseph Allan and a young puppeteer, Margaret Neal are frequent entertainers over WRGB.



time, sets up the equipment, tests the lighting and a rehearsal is held. Whole show must be carefully dovetailed in order to give cameras time to move through the halls and be ready for the next pick-up. This also complicates the installation problem for cables must be so laid that there's no tangling up. On the show reviewed, a blacksmith's shop, complete with an authentic blacksmith in his 80's, metal welding and the foundry shop were picked up. Entertainment note was added in the opening, with a tot, dressed in hoop-skirt, visiting the blacksmith and reciting "Under a Village Chestnut Tree." After the smithy had explained his craft and showed some of his tools, camera moved to the metal welding demonstration with explanation given by a museum guide, and then to the foundry shop, an exact working replica of a big industrial plant, where the viewers saw the furnace, the molten lead and the plaques being made. Idea might well be used by other stations for educational or civic interest programming.

AUDIENCE SURVEY

WBKB poll shows demand for more dramatic shows

Recently concluded survey of 1,071 persons in Chicago—which polled 40.5% or 434 returns—showed that WBKB viewers wanted additional dramatic, educational and news shows from the studio. Judged on the basis of current fare, though, sports and remotes culled 50% of the votes, live shows 30%, and films 20%. About 2/3 of the questionnaires were returned from home owners; the other 1/3 from taverns and places of business. Viewers also wanted more children's programs, a well illustrated nightly news commentary or a newsreel.

Time Segments

On program length, the 30-minute shows got the nod with 201 votes against 83 for the 15-minute segments. Favorite viewing hours were 7 to 11 in the evening, with 78 votes, as against 61 votes for 8 to 11; afternoon favorite was the 3 to 5 slot, which polled 38 votes. Majority preferred complete coverage of a

sporting event—236 versus 102 who wanted just the main event.

On commercials, 169 preferred them at the beginning; 31 in the middle; 103 at the end; 81 integrated, 4 not integrated, and 7 had no preference.

New Schedule

Following through on the survey, WBKB has stepped up their dramatic shows. Under Beulah Zachary's direction, "The Importance of Being Earnest" was styled for tele. Hour and a half play had intermissions every thirty minutes in the

theatre manner. At press time, pick-up from the Eighth Street Theatre of the original play "Night Without End" was scheduled with Miss Zachary acting as field director.

Tuesday evening spot alternates weekly between "Jailbait" and tele-versions of the classics, both under the direction of Kit Carson. "Jailbait" dramatizes case histories of juvenile delinquents in familiar everyday settings. Other series has included 30 to 40 minute adaptations of Poe's "Telltale Heart," Maupassant's "The Diamond Necklace," passages from Macbeth, and

Wilde's "Sir Arthur Savile's Dilemma," adapted for television by Bill Vance.

To meet the demand for more music, Lewis Gomavitz produces musical comedy miniatures in the afternoon spots, with boy meeting girl and singing romantic songs — to recorded music, of course. In addition there are the American Medical Association's shows aimed to popularize public health education, produced by Lorraine Larson.

Stepped up studio programming has resulted in some heavy fan mail for the WBKB crew and Capt. Bill Eddy.

One Man's Reflections (Continued from page 20)

They will create the mass market which will keep the factory wheels rolling and which will produce as well the great television audience that will justify the considerable expenditures which are needed for programs of high quality.

Mass Market

Once a mass television audience has been created the prosperity of the television broadcaster is probably assured. Accordingly, the public, the manufacturer, the broadcaster and the program sponsor alike, have a real interest in the creation of a mass market for television receivers.

Offhand this may sound like laying down an impossible specification for the cost of the highly complicated television receivers of to-

day. Still, when one views the amazing strides made in the simplification and mass manufacture of standard radio receivers, one may have some hope that technical and manufacturing ingenuity will, at least in limited measure, do something of the same sort for television as well. In the old days of television there were many so-called "impossibilities." Hot arguments raged about the question of whether 45 line or 60 line television was acceptable.

No Limit on Skill

When an unusually unrestrained engineer then suggested that the pictures should actually have some 500 lines, the present-day figure, a perfect hurricane of protest at once arose. The flat assertion was made

that such pictures "were impossible." And so they were, in the state of the art at that time. But it is never wise or prudent to lay down the limits beyond which manufacturing skill and technical achievement shall not pass.

Gradual Development

Accordingly, in a spirit of attempted helpfulness, the writer suggests that as much of each of the specifications here suggested for the "ideal" television receiver be approached as is practicable at each stage of television development. And he has full confidence that the years will show that the greater portion of these specifications can be and will be met, through technical and production ingenuity, to the advantage of the public and the television industry.

Television Outlook in St. Louis (Continued from page 9)

terest in television. From a commercial point of view, the Greater St. Louis television society is being formed, composed of manufacturers, dealers, station personnel, installation depots, service men, advertising agencies, etc. Although still in the blueprint stage, they hope in time to have committees from each group so that a particular problem can be handled by a specific committee. Association will act as a clearing house for all television interests, rather than have several groups working on their own.

Promotional Activities

Meetings and demonstrations have been held with the Chamber of Commerce, advertising clubs, etc. Idea was to get the men there who approve the budget and by putting on a series of shows, tailored for commercial treatment, to prove to them that television can help sell.

To promote consumer interest, UE's future plans call for a speaker group to address such local groups as the PTA, and to clinch the speech with a demonstration; to keep their auditorium open for viewing purposes, and to program over the station, in order to support it financially.

Right now there are about 400 sets in St. Louis, with more scheduled. Station keeps track of the growing audience by obtaining the names and addresses of every owner from the distributor and the installation center. New owners are then sent a card of welcome and their name is put on the mailing list to get the programs, etc.

AS for KSD-TV, their viewpoint is optimistic. George M. Burbach, general manager of the station, states that in his opinion the TV operation will be in the black in two years.

Technical features of the Zoomar lens . . . High speed film developing process shown

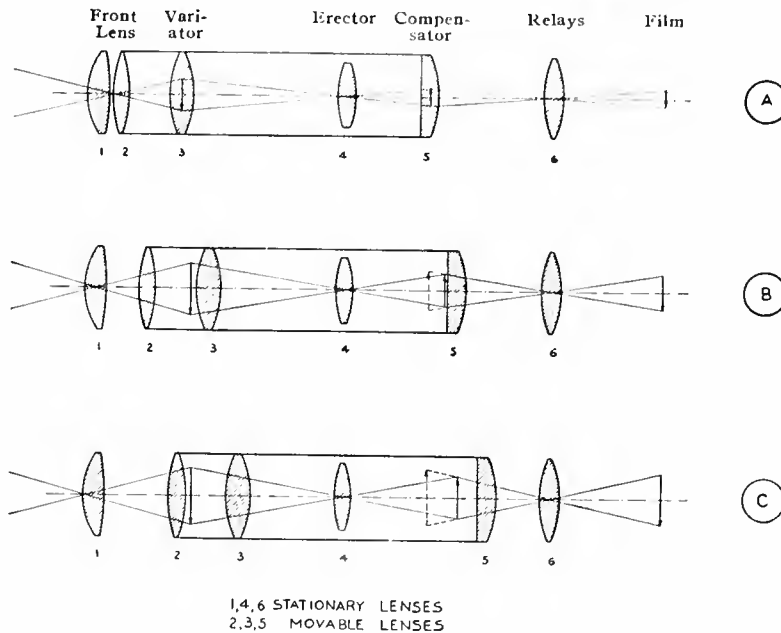

THE principle of a zoom lens is not exactly a new one. For many years Hollywood has been offered a great variety of zoom developments, none of which they have accepted. Some twenty-five years ago the Taylor-Hobson zoom lens was imported from England by Bell & Howell. The characteristics of this lens, as reported, were excellent, but to date no zoom lens

has been able to keep a true focus throughout the zoom.

First tests indicate that this is also true of the Zoomar lens. In television, however, there is a strong indication that if the rental fee planned by Fairbanks Company is not too high a one, the Zoomar lens will become practically standard equipment for remotes and special studio work.

While the idea of vari-focal lenses is not new, the zoom lens as developed by Dr. Frank G. Back, eliminates any of the mechanical difficulties presented by the other systems. Back's lens has only one movable barrel, and the compensation of the image movement is achieved with optical, rather than mechanical means.

There are two groups of elements in the Zoomar lens, stationary, and coupled movable elements. The stationary elements are mechanically connected by the housing. The coupled movable elements are mounted in a common barrel. Movement of the barrel to any position in the housing yields a stationary image of varying size.

Fig. 1 shows a simplified schematic view of lens arrangement in three positions. Position A is the wide-angle position; position B the medium position; and position C the telephoto position.

Elements 1, 4, and 6 are the stationary group. Elements 2, 3, and 5 are the movable group. The stationary elements do not change their position within the lens housing; elements 2, 3, and 5 are moved simultaneously. The effect is a picture of variable size but stationary as far as displacement along the lens axis is concerned.

Although Fig. 1 shows the principle of the new zoom lens, each lens element shown represents a group of lens components in itself, because every one of these lenses has to be corrected for chromatic and spherical aberration and for astigmatism. Coma and distortion are eliminated by the concerted interplay of all groups.

The technical data of the Zoomar television lens are:

Aperture range: f/4.5 to f/30; telephoto from 5.6.

Range: from infinity to approximately 5 feet. With telephoto lens, infinity to approximately 15 feet. Zoom range: from 3 to 9 inches; telephoto 7 to 18 inches.

Tests made according to RCA test pattern, according to Dr. Back, show that the Zoomar lens is capable of a resolution in the center of 600 lines and in the corners of 400 lines. It is Dr. Back's feeling that this resolution can still be improved,

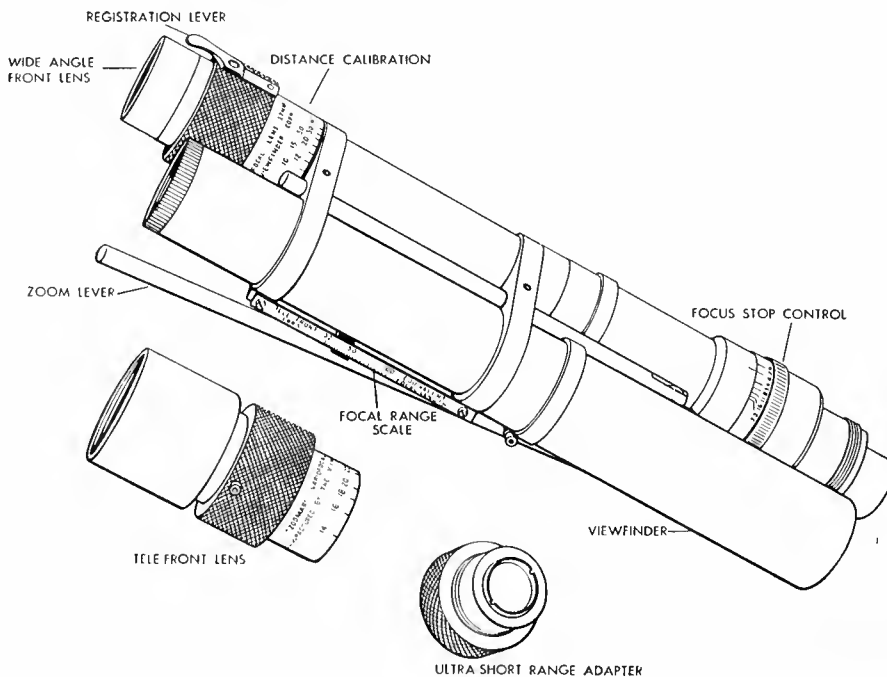

Professional Directory

RING & CLARK

Consulting Radio Engineers

WASHINGTON, D. C.

Munsey Bldg. Republic 2347

FRANK H. McINTOSH

Consulting Radio Engineers

710 14th ST., N. W. ME. 4477

WASHINGTON, D. C.

McNARY & WRATHALL

Consulting Radio Engineers

National Press Bldg. DI. 1205

WASHINGTON, D. C.

JANSKY & BAILEY

*An Organization of
Qualified Radio Engineers
DEDICATED TO THE
Service of Broadcasting*

National Press Bldg., Wash., D. C.



COMMERCIAL RADIO EQUIPMENT CO.

*Radio Engineering Consultants
Complete engineering services for
applicants, owners and operators of*

AM-FM-TV-FAX
Broadcasting Stations
OFFICES

International Bldg., Washington 4, D. C.
Porter Bldg., Kansas City, Mo.

WORTHINGTON C. LENT

Consulting Engineers

International Bldg. Wash., D. C.

1319 F Street, N. W. District 4127

PAUL GODLEY CO.

Consulting Radio Engineers

Upper Montclair, N. J.

Labs: Great Notch, N. J.

Phone: LITTLE FALLS 4-1000

GEORGE C. DAVIS

Consulting Radio Engineer

Munsey Bldg. District 8456

WASHINGTON, D. C.

JOHN CREUTZ

Consulting Radio Engineer

319 Bond Bldg. REpublic 2151

WASHINGTON, D. C.

WINFIELD SCOTT McCACHREN AND ASSOCIATES

*Consulting Radio Engineers
TELEVISION SPECIALISTS*

410 Bond Bldg. 809B Windemere Ave.
Washington 5, D. C. Drexel Hill, Pa.
District 6923 Sunset 2537W

DIXIE B. McKEY & ASSOCIATES

1730 Connecticut Avenue
N.W. Washington 9, D. C.
Telephone: Adams 3711

Dixie B. McKey
Dabney T. Waring, Jr.

JOHN BARRON & ASSOCIATES

*Specializing in Broadcast and
Allocation Engineering*

Earle Building, Washington 4, D. C.
Telephone National 7757

HOYLAND BETTINGER

Television Consultant

*Studio Design, Lighting,
Personnel Training*

595 Fifth Avenue PLaza 8-2000

BROADCASTING STUDIOS

*Design and Construction
Television, also F.M. and A.M.
THE AUSTIN COMPANY
Cleveland*

A Nation-Wide  Organization

Consulting Radio Engineer

JOHN J. KEEL

Earle Bldg., Washington, D. C.
National 6513

There is no substitute for experience

GLENN D. GILLETT

AND ASSOCIATES
Consulting Radio Engineers
982 National Press Bldg.
Washington, D. C.

RUSSELL P. MAY

Consulting Radio Engineers

1422 F St., N.W., Washington 4, D. C.
Kellogg Bldg. • REpublic 3984

KEAR & KENNEDY

Consulting Radio Engineers

1703 K St. N.W. REpublic 1951
WASHINGTON, D. C.

HAROLD B. ROTHROCK

Consulting Radio Engineer

1909 Eye St., N.W. National 0196
Washington 6, D. C.

CHAMBERS & GARRISON

Consulting Radio Engineers

1519 CONNECTICUT AVENUE
Washington 6, D. C.
Michigan 2261

New York Washington Cincinnati
Chicago Hollywood

RICHARD W. HUBBELL and ASSOCIATES

2101 INTERNATIONAL BUILDING
630 Fifth Avenue, New York 20, N. Y.
Program Production, Studio Design,
Personnel Management Problems,
Public Relations, Merchandising

and will be so. Optically he feels the problems are solved. From now on in all problems are purely mechanical, such as adjusting to different make cameras, placing of controls, etc. Consideration is being given to the possibility of by-passing the cameramen, and electronically controlling the lens by the television program director.

It is repeatedly emphasized that the Zoomar lens is not designed to replace other camera lenses now in use. It was designed for specific situations where it would be advantageous to eliminate camera dollying, and for various special effects which might be helpful to programmers.

High Speed Processing

WORK, by DuMont, Ansco and Kodak, on high-speed processing and special grain film for television use is now coming out of the experimental stage.

Culmination of many years of extensive development in high-speed photo processing by the Eastman Kodak Company, was the successful demonstration of their "hot photography" process by the American Broadcasting Company's television department, in cooperation with the Philco Company.

Press witnessed, via receivers in

Philadelphia, a film which had been taken over Atlantic City an hour before. The film was taken in a plane and developed en route back to the Philadelphia airport, from where it was sent to WPTZ, the Philco station, and without any editing or screening was then transmitted with voice-over commentary.

While high-speed processing is not new to the film industry, the use of heated chemicals and film which can withstand this heat of about 120° Fahrenheit, is a new development. The Kodak machine is an adaptation of an instrument developed by Kodak for the Army during the war.

The machine demonstrated can operate continuously at the rate of eight feet of film per minute. However, it was explained that by enlarging this machine its capacity and rate of speed could be increased by two hundred feet of film per minute. Film can be developed to a negative or positive by this method, depending on the process used.

The solutions, maintained at high temperatures by a thermostatically controlled unit, flow continuously into miniature processing tanks at a rate sufficient to maintain constant photographic quality.

Each of the three tiny tanks holds about an ounce of solution which is

pipled in from quart reservoirs. As excess solutions overflow each tank after five seconds of use, they collect in a trough and are discarded.

The technicians pointed out that by this arrangement the small amount of chemical in the machine at any time is renewed frequently with fresh solutions, thus eliminating most of the chemical problems of film processing.

The continuous flow of chemical solutions, they said, amounts to "using six feet of solution for six feet of film."

During processing the exposed motion picture film, carried on rollers, follows a simple "over-and-under" path through the miniature tanks.

In 15 seconds a frame of film is developed, rinsed, and fixed. Next the film is given a hot spray wash after which it passes between squeegee rollers that remove excess water. Final drying takes place during 15 seconds when the film moves over heated drums.

In stressing the experimental nature of the equipment, Kodak indicated that it sees high-temperature processing as a technique which may eventually complement, rather than replace, present methods of processing used in television and motion-picture fields.

Telescope (Continued from page 5)

place. Show opens May 20th in Reading, then proceeds to Easton, Jamaica, L. I., Boston, Syracuse, Paterson, Harrisburg, Grand Rapids, Columbus, Cincinnati, Tampa, Lake Charles, San Antonio, Dallas, Waterloo, Ia., St. Paul, Boise, Seattle, Spokane, Great Falls, Minneapolis, winding up in Akron on October 18th. Walter L. Dennis, radio and tele director of Allied will travel part of the time with the Caravan.

ANTENNA PROBLEM: TBA interim television installation plan for New York has been rejected by the New York City Real Estate Board. Highlights of the 15-point plan called for permission for a tenant to erect an antenna and necessary lead-in cable, at his own expense, and to have later installations connected to the original dipole installation, provided a good signal could be received. Under the plan, the tenant would be responsible for the original cost and upkeep, although the installation would become the property of the landlord. (And even that didn't satisfy them!)

ASSOCIATIONS: Television Association of Philadelphia was launched last month by representatives of advertising agencies, manufacturers, distributors, and broadcasters. Ken Stowman, WFIL tele director, was elected temporary chairman. . . . One day television technical con-

ference being held May 3 by the Cincinnati Section of the IRE in that city covered television receivers "from antenna to image" in the papers presented. . . . Televiser held a two-day Institute session in New York at which major problems confronting the industry were discussed.

PERSONNEL: Kenneth W. Stowman has been named director of television for WFIL, Philadelphia. Mr. Stowman had previously been assistant to the general manager of radio station WFIL. . . . J. Harrison Hartley, director of news and special features for NBC television, has joined WEWS, Scripps-Howard station now under construction in Cleveland. . . . M. A. Trainer, one of the real tele coonskin cappers, has been named manager of the RCA television equipment sales division. . . . John G. Wilson has been appointed vice president and general manager of RCA, with Fred D. Wilson named vice president in charge of operations and Joseph H. McConnel, vice president in charge of law and finance. . . . George E. Gautney and Clyde H. Bond have become associated in the operation of John Barron, consulting radio engineers. . . . Executive offices of RKO Television Corporation have moved to 625 Madison Avenue, New York. New 11-store studio and laboratory at 106th Street and Park Avenue is rated most complete plant in the East.

Henry C. Lytton Co. (Continued from page 13)

down to earth patter. And fact that the person rejected some gifts, as not being just what they wanted, took the commercial out of the too-frequently heard, adjective studded "It's just what I wanted" and "too, too wonderful" class.

Occasionally a lead-in by Joe Wilson was used to set the scene. When the action took place in the store, a very modern impressionistic drawing of the store was used, with the name plate placed at a jaunty angle. Camera dollied in on the name plate and then dissolved to the scene.

Three or four oral quickies were also given by Joe Wilson at dull moments during the game. Typical were such brief slogans as "Look to Lytton's—for America's best known merchandise!" and "You'll find the answer to all your shopping problems at Lytton's in Chicago, Evanston, Oak Park and Gary."

Rehearsal Timetable

Script was ready the Monday preceding the telecast and necessary revisions made. After approval by the client on Tuesday, sets, props and special effects were ordered immediately. Casting was done Wednesday morning, with copies of the script given to the cast. On Friday afternoon, a "dry run" rehearsal, lasting about an hour, was held, with the script read for interpretation, action blocked and basic business set. On Saturday, the station crew set up for the program, and deliveries were checked from the store to make sure that all items were on hand.

With the show scheduled for 8:25, rehearsals began in the studio about 6:30 p.m., with Beulah Zachary,

WBKB director, Fred Kilian, ABC producer and Fran Harris. During the first half-hour, each skit was gone through twice to check lines, action and business with the actual props. At seven the camera rehearsal started. The first time through, the cast was stopped where necessary; on the second try, business was polished up and new ideas added; the third time a rough timing was taken. Same procedure was gone through for the second commercial.

After the hockey game started, the scene was reset for the first commercial and a "dress" held. At the end of the first period of the game, cut back to the station was made and immediately after station identification, the commercial went on. During the second period, the scene was set for the second commercial and the "dress" held.

As for talent, almost all had radio, stage and television experience. Using inexperienced people would require more coaching time than could be allotted in the tight rehearsal schedule followed.

On sets, station prop department was checked first to see if they had the type of background needed. If not, the store display department was utilized in devising the special effects required. When a particularly elaborate set was necessary, it was built by a theatrical scenic house in Chicago.

Summing It Up

As for what Lytton's thinks of television, read Mr. Cole's statement on page 12. And as proof of the pudding, although they are off the pix-waves now, they will probably be back in the fall.

Report on Joint Television Committee (Continued from page 15)

pay \$85 to principals, \$60 to chorus. "B" clubs pay \$75 and \$45 and "C" spots pay \$60 and \$40.

Actor's Equity itself is headed by Paul Dulzell, who, as Executive Secretary and Treasurer, is the operating chief of the organization. Chorus Equity, a subsidiary represented on the AEA board, is headed by Ruth Richmond. AEA's minimums for principals in "productions" (which means any professional play or show in or out of New York), is \$60. Stock company rates are \$46 for principals. Chorus minimum is \$50 in New York and \$55 for road companies.

AFRA

The union with which television men are most likely to be acquainted is the American Federation of Radio Artists, a gingery outfit headed by George Heller, who also chairs the television committee. AFRA has a clean record in most respects and its recent victory over the radio networks has given it great strength and the fullest confidence of its members. AFRA was founded in 1937, following the passage of the Wagner Act, and granted a charter in the same year by the 4As. Its first network contracts were won in 1939. Its leadership is among the most progressive—and the most aggressive—in the whole field. In describing AFRA one radio executive said: "They give you a tough fight—but it's a clean one." AFRA has 20,000 members.

SAG

The Screen Actors Guild, another member of the 4As, will be a potent force in television. SAG came into the 4As in 1934, after a long and wearing struggle with the producers and with the Academy of Motion Picture Arts and Sciences. The Academy, according to the SAG, was originally established as a company union to lick SAG wage demands. When the Wagner Act was passed and company unions were outlawed, SAG signed contracts with the studios and now controls nearly all the actors in the motion picture field. The executive secretary and operating head of SAG is John Dales, Jr., but the official with whom television managements are most likely to deal is Florence Mars-ton, Eastern Representative.

SAG's minimum wage scales mean very little for featured players and stars, of course, but extras are paid \$15.50 daily and extras who speak lines get \$35.00 a day.

There is little doubt that performers are tired of low pay—or no pay—in television. But by the same token, they have shown intelligence enough not to make excessive demands at a time when the industry is unprepared to meet them. A situation like the one created by the American Federation of Musicians will never develop in television's relations with actors. If management is willing to meet the unions half way—as the unions have done—there should be no difficulty in signing an agreement.

It's like that radio man said: "They'll give you a tough fight—but a clean one."

EDITORIAL

IN OUR Industry Report for April, we published a survey on mid-West television. More than fifty advertising and agency executives were interviewed. With few exceptions, they were not satisfied with present-day television. They could see little reason why their clients' money should be expended at this time. They complained of poor programming, inadequate facilities, and so forth.

While some of their claims were justifiable, the role they choose to play is not. Where would our automobile industry be if men had waited until the millions of miles of roadway systems were built? Where would our aviation industry be if men had waited for guarantees of passenger mileage and adequate airports throughout the country?

Agencies, by and large, are guilty of not only a short-sightedness, but a failure to fulfill their obligations to their clients. It is the obvious duty of every advertising agency to be fully informed on all advertising media. It is not possible for agencies to learn about television by hearing a few "experts" lecture on this new medium. Experience is necessary—experience in producing commercial television shows. Every agency should establish a definite budget for television experimentation, and if this means slicing off a few percent of their new business budgets, no one will be the worse off.

A good measure of the progressiveness of an advertising agency would be their television activity, and by television activity we don't mean a "television department" run by a recently-promoted office boy.

Everything's Going To Be All Right

With this issue TELEVISION Magazine enters its fourth year of publication. There are still many rough spots and growing pains. Mediocre programming, installation problems, inadequate deliveries, are all greatly magnified because of the smallness of the industry. Other more established industries have problems just as great. It's too easy, because of the many "experts" in the field, to confuse the status of television. It's a very healthy one, as healthy as any new industry can be. Its problems are no greater than those of any other industry. Most of them will disappear as television receiver production increases. There's only one major problem, only one important factor upon which everything else revolves, and that is receiver production. Set production is well under way. The industry should produce some 300,000 units during 1947, and by 1948 production will be largely governed by demand rather than facilities. As receiver deliveries increase, programs will improve. Advertising interest will pick up, and gradually and logically, as receiver production increases, the price will come down. Let's stop all the unnecessary griping and concentrate on doing as good a job as possible in our respective fields.



Television gives you a choice seat at the game.

Television—a Season Pass to Baseball !

Every home game—day or night—played by the New York Giants, Yankees and Brooklyn Dodgers will be seen over television this season!

Owning a television receiver in the New York area will be like having a season pass for *all three ball clubs*. And in other cities, preparations for the future telecasting of baseball are being made.

When more than one home game is on the air, baseball fans can switch from one to the other—see the most exciting moments of each through television!

Those who own RCA Victor television receivers will enjoy *brighter, clearer, steadier* pictures through the exclusive RCA Victor Eye-Witness picture synchro-

nizer that “locks” the receiver in tune with the sending station.

To witness baseball or any other event in the ever-growing range of television programs—you’ll want the receiver that bears the most famous name in television today—RCA Victor.

When you buy an RCA Victor television receiver or radio, or Victrola radio-phonograph, or an RCA Victor record or a radio tube, you know you are getting one of the finest products of its kind science has achieved.

“Victrola” T.M. Reg. U.S. Pat. Off.

Radio Corporation of America, RCA Building, Radio City, New York 20. Listen to the RCA Victor Show, Sundays, 2:00 P.M., Eastern Standard Time over the NBC Network.



Several television cameras cover the baseball diamond to bring you a close-up of the action wherever it occurs. Here is a supersensitive RCA Image Orthicon television camera used by NBC's New York station WNBT in televising home games of the New York Giants.



RADIO CORPORATION of AMERICA



Start

small

with

the

DuMont Acorn Package

With the Du Mont Acorn Package, a television broadcaster can start in a small way. Small equipment cost. Small operating cost. As the station grows, he simply adds on more equipment units like building blocks.

Remember, Du Mont has been in television for 15 years . . . has built more television stations than any other company.

Du Mont's "know-how" can save you money right from the start . . . can help you avoid costly mistakes.

Call, phone or write for full information about the Du Mont Acorn Package.

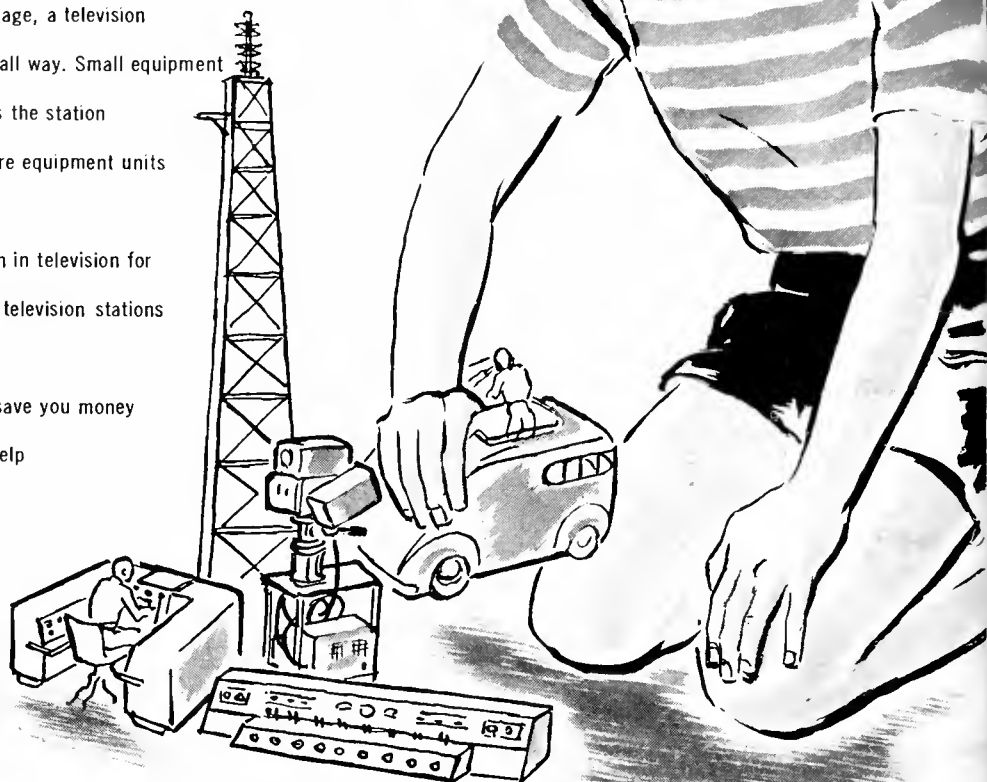

DU MONT

First with the finest in Television